



ifm  
ifm  
ifm  
ifm  
ifm  
ifm

# NEWSBOOK 2021

innovation  
innovation  
innovation  
innovation  
innovation  
innovation  
innovation  
innovation  
innovation  
innovation

Product innovations automation technology

# ifm products

ifmnovation · NEWSBOOK 2021



## Position sensors

### Inductive sensors

*Huge IO-Link performance in a tiny M8 housing*

6 - 7

*Twice as good: inductive sensors with analogue output and IO-Link*

8 - 9

### Capacitive sensors

*On the safe side: capacitive IIoT sensors for hazardous dust areas*

10 - 11

*KQ10 for continuous range monitoring of point levels*

12 - 13

### Photoelectric sensors

*Measuring light grids for easy object monitoring in intralogistics*

14 - 15

*The PMD profiler: up to 10 target profiles for precise quality assurance*

16 - 17

*OGD with plastic front lens: distance measurement with added safety*

18 - 19

### Valve feedback systems

*Always know where you stand: position feedback for ball valves*

20 - 21

## Sensors for motion control

### Encoders

*A safe choice: draw-wire mechanisms for encoders*

22 - 23

### Systems for signalling and indication

*Decentralised and smart monitoring of rotating machines*

24 - 25

## Industrial imaging

### 3D sensors

*Accelerate pallet detection using 3D cameras*

26 - 27

### 3D cameras

*Collision protection for automated guided vehicle systems*

28 - 29

### Illumination

*Flexible LED strip for illumination and signalling*

30 - 31

*Ultra-flat backlight for vision sensors*

32 - 33

## Safety technology

### Fail-safe inductive sensors

*Simply reliable: fail-safe sensors for mobile machines*

34 - 35



## Process sensors

### Pressure sensors

*Front flush miniature pressure sensor with G1/4 process connection*  
*With E1 approval: Pressure transmitters for mobile machines*

36 - 37  
38 - 39

### Flow sensors / flow meters

*More than hot air: flow sensor ensures safety*

40 - 41

### Level sensors

*Better without a float: maintenance-free capacitive level measurement*

42 - 43

### Analytical sensors

*Air humidity sensor: ensure the perfect climate for your processes*  
*Conductivity sensor for clamp and hygienic pipe fittings*

44 - 45  
46 - 47

## Industrial communication

### AS-i interface I/O modules

*For AS-i and IO-Link: passive power distributor for hygienic areas*

48 - 49

### Industrial Ethernet switches

*Robust data distribution: Ethernet switches for field applications*

50 - 51

## IO-Link

### IO-Link master

*IO-Link master: Connection of sensors to the PLC and to the IT world*  
*IO-Link master for intelligent sensors in the control cabinet*  
*Connect IO-Link to a PC via USB*

52 - 53  
54 - 55  
56 - 57

### PROFIsafe IO-Link module

*Safety over IO-Link*

58 - 59

### IO-Link accessories

*io-key – the key to the industrial IoT*

60 - 61

## Identification systems

### RFID UHF

*No compromises: robust UHF evaluation system for harsh environments*

62 - 63

## Systems for condition monitoring of machines

### Systems for vibration monitoring and diagnosis

*Smart vibration monitoring without cabling*

64 - 65



## Systems for mobile machines

### I/O modules

*ioControl – rugged I/O module with integrated controller*

66 - 67

### Units for operation and monitoring

*ecomatPanel: robust, multifunctional input module*

68 - 69

### Cameras for mobile applications

*3D collision warning system for mobile machines*

70 - 71

## Connection technology

### Industrial applications / factory automation

*ecolink M12, Ethernet D-Code for industrial applications*

72 - 73

*ecolink M12 / RJ45: Ethernet cables for industrial applications*

74 - 75

### For use in mobile and robust applications

*M12 CAN cables ecolink for mobile machines*

76 - 77

## moneo

### moneo

*moneo. The all-you-want software for industrial evolution*

78 - 83

## ifm

### ifm

*ifm system sales – solutions for your installation from a single source*

84 - 85

*The ifm sales platform*

86 - 87



Position sensors

# Huge IO-Link performance in a tiny M8 housing



Inductive sensors



Long sensing range, minimal space required

Easy installation and replacement thanks to standard M8 connector

- ↻ The ideal solution where space is at a premium: remote IO-Link parameter setting
- ↻ Process reliability guaranteed by switch point monitoring for detection of wear
- ↻ Diagnostic functions, such as internal unit temperature monitoring, help prevent failures

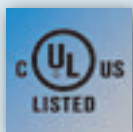

### Excellent performance in a small housing

With 3 mm (flush) and 6 mm (non-flush), the sensing range is much than the standard of conventional M8 sensors. Thanks to the high switching frequency of 600 Hz, the sensors also solve demanding position detection tasks where space is limited.

### More performance thanks to O-Link

In addition to the switching output, the sensor has an IO-Link interface. Convenient remote parameter setting is also possible. Thanks to the high precision, the user can monitor the switch point to the nearest millimetre and detect mechanical deviations e.g. caused by wear at an early stage. Extensive diagnostic functions, such as integrated unit temperature monitoring, provide additional safety in the installation by sending early warnings in critical applications.



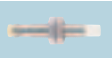

| Type  | Installation | Measuring range [mm] | Setting range [mm] | Correction factor   | Order no.     |
|---|--------------|----------------------|--------------------|---|---------------|
|  | flush        | 0.3...3              | 0.56...2.8         | Steel 1 · stainless steel 0.7 · brass 0.4<br>aluminium 0.4 · copper 0.3 | <b>IE5457</b> |
|  | non flush    | 0.6...6              | 1.23...5.61        | Steel 1 · stainless steel 0.7 · brass 0.5<br>aluminium 0.5 · copper 0.4 | <b>IE5456</b> |



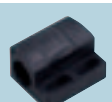

## Accessories

| Design | Description | Order no. |
|--------|-------------|-----------|
|--------|-------------|-----------|



### Installation

|  |  |               |
|--|--|---------------|
|   | Mounting bracket for M8 housing, stainless steel         | <b>E10734</b> |
|   | Mounting clamp for M8 housing, aluminium, black anodized | <b>E10221</b> |
|  | Mounting clamp for type M8, PC                           | <b>E11521</b> |

### IO-Link

|   |  |               |
|---|--|---------------|
|  | IO-Link master DataLine, USB   | <b>AL1060</b> |
|  | Memory plug, parameter memory for IO-Link sensors  | <b>E30398</b> |
|  | <b>moneo configure SA</b><br>(Stand-alone) licence, software for online and offline parameter setting of IO-Link devices including maintenance and support until the end of the following year | <b>QMP010</b> |
|  | IO-Link display  | <b>E30391</b> |

### Connection technology

|   |   |               |
|---|---|---------------|
|  | Connection cable, M8, 3-pole, 2 m, black, PUR cable | <b>EVC268</b> |
|  | Connection cable, M8, 3-pole, 5 m, black, PUR cable | <b>EVC269</b> |

## Wiring diagram

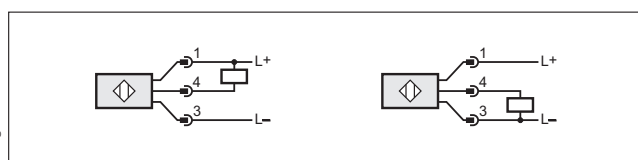

## Further technical data

|                                  |  |            |
|----------------------------------|--|------------|
| Design                           | M8 x 1   |            |
| Housing length                   | [mm]   | 50         |
| Electrical design                | DC PNP / NPN<br>can be set via IO-Link   |            |
| Output function                  | NC / NO adjustable<br>via IO-Link  |            |
| Operating voltage                | [V DC]   | 10...30    |
| Current rating                   | [mA]   | 100        |
| Reverse polarity protection      | ja   |            |
| Short-circuit protection         | ja   |            |
| Protection rating                | IP 65 / IP 66 /<br>IP 67 / IP 68 / IP 69 K   |            |
| Protection class                 | III  |            |
| Switching frequency DC           | [Hz]   | 600        |
| Ambient temperature              | [°C]   | -40...75   |
| Switching status indication      | [LED]  | 4 x yellow |
| IO-Link process data (cyclic)    | Function   | Bit length |
|                                  | Process value  | 16         |
|                                  | Device status  | 4          |
|                                  | Binary switching information   | 2          |
| IO-Link process data (acyclical) | Switching cycles counter,<br>switch-on cycles counter,<br>operating hours counter,<br>internal temperature,<br>application-specific<br>marking |            |

## Dimensions

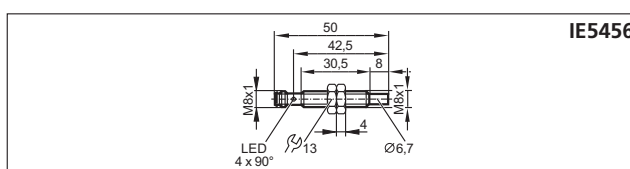
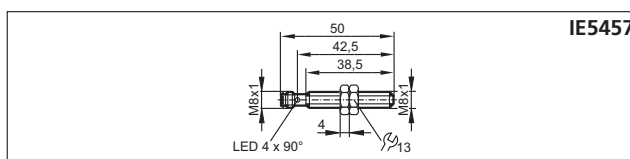

We reserve the right to make technical alterations without prior notice. · 04.2021



Position sensors

# Twice as good: inductive sensors with analogue output and IO-Link.



## Inductive sensors



High-precision distance measurement for early diagnosis of mechanical changes.

Distance measurement and switch using only one unit.

- Flexible use due to adaptable output range.
- Measured value transmission without any loss via IO-Link.
- More functionality with full compatibility using standard input devices.

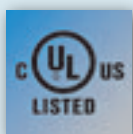

### Prepared for plant retrofit

The new inductive analogue sensors are fully compatible for use in existing plants. A wide range of functions and information are provided additionally via IO-Link.

### Increased measurement accuracy with IO-Link

On the one hand, conversion losses or electromagnetic interference are avoided thanks to digital communication. On the other hand, the detection range of the sensor is freely scalable via IO-Link – allowing also adjustment of the switch-on curve. Thus, the resolution can be specifically maximised whenever tiny changes in distance, for example caused by first stages of wear, need to be detected quickly. When connected to an ERP, the digital data can be used to implement automated, demand-based maintenance.







| Type   | Total length<br>[mm] | Measuring range<br>[mm] | Installation | Output signal | Protection rating | Order no.     |
|--|----------------------|-------------------------|--------------|---------------|-------------------|---------------|
| <b>M12 connector · analogue output programmable/ IO-Link</b> |                      |                         |              |               |                   |               |
| M12  | 70                   | 0.2...2                 | flush        | 4...20 mA     | IP 65...IP 69K    | <b>IF6028</b> |
| M12  | 70                   | 0.2...2                 | flush        | 0...10 V      | IP 65...IP 69K    | <b>IF6029</b> |
| M12  | 70                   | 0.4...4                 | non flush    | 4...20 mA     | IP 65...IP 69K    | <b>IF6030</b> |
| M12  | 70                   | 0.4...4                 | non flush    | 0...10 V      | IP 65...IP 69K    | <b>IF6031</b> |
| M18  | 60                   | 0.8...8                 | non flush    | 4...20 mA     | IP 65...IP 69K    | <b>IG6083</b> |
| M18  | 60                   | 0.8...8                 | non flush    | 0...10 V      | IP 65...IP 69K    | <b>IG6084</b> |
| M18  | 60                   | 0.5...5                 | flush        | 4...20 mA     | IP 65...IP 69K    | <b>IG6086</b> |
| M18  | 60                   | 0.5...5                 | flush        | 0...10 V      | IP 65...IP 69K    | <b>IG6087</b> |
| M30  | 65                   | 1...15                  | non flush    | 4...20 mA     | IP 65...IP 69K    | <b>II6913</b> |
| M30  | 65                   | 1...15                  | non flush    | 0...10 V      | IP 65...IP 69K    | <b>II5914</b> |
| M30  | 65                   | 1...10                  | flush        | 0...10 V      | IP 65...IP 69K    | <b>II5917</b> |
| rectangular  | 40 x 40 x 54         | 1...15                  | flush        | 4...20 mA     | IP 67             | <b>IM5139</b> |
| rectangular  | 40 x 40 x 54         | 1...15                  | flush        | 0...10 V      | IP 67             | <b>IM5140</b> |
| rectangular  | 40 x 40 x 54         | 1...26                  | non flush    | 4...20 mA     | IP 67             | <b>IM5141</b> |
| rectangular  | 40 x 40 x 54         | 1...26                  | non flush    | 0...10 V      | IP 67             | <b>IM5142</b> |
| rectangular  | 40 x 40 x 54         | 3...35                  | non flush    | 0...10 V      | IP 67             | <b>IM5143</b> |
| rectangular  | 40 x 40 x 54         | 3...35                  | non flush    | 0...10 V      | IP 67             | <b>IM5175</b> |





## Accessories

| Type | Description | Order no. |
|------|-------------|-----------|
|------|-------------|-----------|

### Installation

|   |   |               |
|---|---|---------------|
|  | Angle bracket for M12 design, stainless steel | <b>E10735</b> |
|  | Angle bracket for M18 design, stainless steel | <b>E10736</b> |
|  | Angle bracket for M30 design, stainless steel | <b>E10737</b> |

### IO-Link

|   |  |               |
|---|--|---------------|
|  | 1-port IO-Link master (connects IO-Link sensors to the PC via USB)   | <b>AL1060</b> |
|  | Memory plug, parameter memory for IO-Link sensors  | <b>E30398</b> |
|  | IO-Link master EtherNet/IP, 4-port   | <b>AL1320</b> |
|  | <b>moneo configure SA</b><br>(Stand-alone) licence, software for online and offline parameter setting of IO-Link devices including maintenance and support until the end of the following year | <b>QMP010</b> |

## Focus area with highest resolution

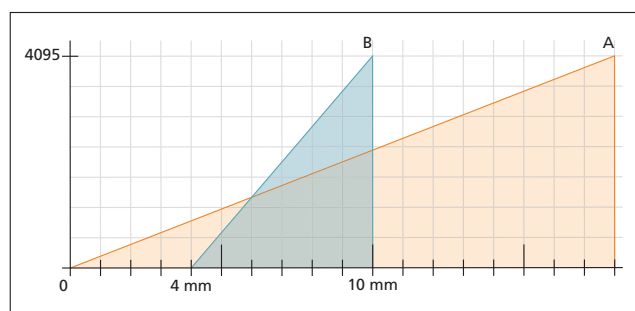

A = detection zone, B = focus zone

In the case of measuring sensors, the 4096 measuring points (i.e. the resolution) extend over the entire detection zone (A).

With the new analogue sensors, however, this resolution can be (e.g.) specifically maximised in any focus zone where minimal changes in distance need to be detected quickly.

For this purpose, all available 4096 measuring points are "placed" in the particular zone to be considered.

In present example, this results in the highest possible resolution of 628 measuring points per mm. This precise measurement accuracy not only increases process reliability, but can also prevent rejects, thus allowing substantial savings.



Position sensors

# On the safe side: capacitive IIoT sensors for hazardous dust areas



## Capacitive ATEX sensors



**Level and position detection in hazardous areas**

**No switching amplifier required, reducing costs and complexity**

**Robust and impact resistant housing**

**Easy connection via M12 connector (straight or angled)**

**Easy remote parameter setting and process monitoring**

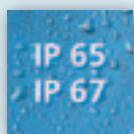

### Maximum protection ensures safe operation

The robust and impact resistant housing of the capacitive ATEX sensors ensures safe operation in hazardous dust areas (ATEX zone 22). No expensive switching amplifiers are required. Level and position can be monitored without any risk, as no combustible energy from the sensor can penetrate into the hazardous area, even in long-term use.

### Intelligent remote diagnostics and control

The ifm sensors are not only the first on the market to feature a standard M12 connector, they are also the first ones featuring IO-Link. This enables safe and convenient remote parameter setting, which is a great advantage e.g. in case of high tanks or limited space. Another advantage is the digital process value transmission which ensures for example that tanks are filled as required. The sensors can be used to easily replace currently installed sensors and used without IO-Link thanks to their backward compatibility.



## The all-rounder for position and process monitoring

The capacitive IO-Link ATEX sensors have been designed especially for zone 22 hazardous dust areas. The well-known M30 sensors with a high sensing range are found in many applications in position and process monitoring.

Examples include the non-contact detection of grain in mills or silos and position detection of bakery products, wood, plastic parts or even pasta. This makes the sensors real all-rounders.

### More flexibility with IO-Link

The sensors are the first to feature an integrated IO-Link chip, allowing them to deliver their full potential. Process values can be transferred in real-time and the sensors can be conveniently adapted to the application remotely.

### Put an end to extensive stock-keeping

Each sensor can be set to PNP or NPN as well as NO or NC, which is an advantage especially for overflow or dry running applications. Integrated time functions can be used to implement automatic replenishment without an upstream controller. The complementary switching output of the sensors can be set directly on the unit via a potentiometer or via IO-Link. The potentiometer can also be deactivated to prevent external influences.

### Dimensions

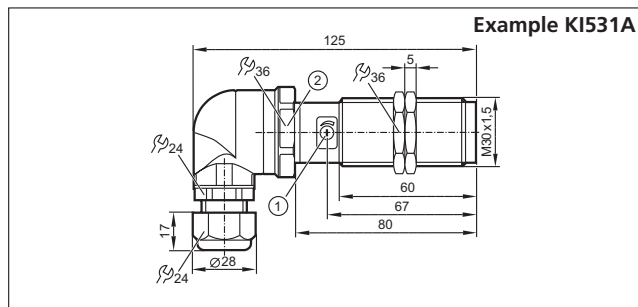

- 1) Potentiometer
- 2) Tightening torque 10 Nm

### Wiring diagram

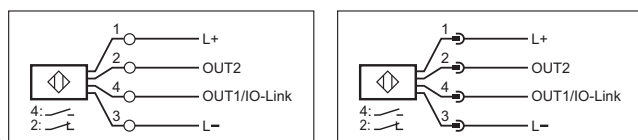

KI530A, KI531A

KI532A, KI533A

| Type | Description | Order no. |
|------|-------------|-----------|
|------|-------------|-----------|

### Use in hazardous dust areas (ATEX zone 22)

|  |                                       |        |
|--|---------------------------------------|--------|
|  | Type M30 with terminals; straight     | KI530A |
|  | Type M30 with terminals; angled       | KI531A |
|  | Type M30 with M12 connector; straight | KI532A |
|  | Type M30 with M12 connector; angled   | KI533A |

### Common technical data

|                         |        |                             |
|-------------------------|--------|-----------------------------|
| Operating voltage       | [V DC] | 10...30                     |
| Current consumption     | [mA]   | 200                         |
| Output function         |        | complementary               |
| Protection rating       |        | IP 65, IP 67                |
| Sensing range [mm]      |        | 15                          |
| Real sensing range (Sr) |        | ± 10 % of Sn                |
| Setting range           |        | 3..26                       |
| ATEX labelling          |        | II 3D Ex tc IIIC T90°C Dc X |

### Accessories

| Type | Description | Order no. |
|------|-------------|-----------|
|------|-------------|-----------|

### Installation

|  |  |        |
|--|--|--------|
|  | Mounting adapter POM; G 1 1/2 external thread          | E11033 |
|  | Mounting adapter PVDF; G 1 1/2 external thread         | E11034 |
|  | Mounting adapter POM; G 1 1/4 external thread          | E11035 |
|  | Mounting adapter PVDF; G 1 1/4 external thread         | E11036 |
|  | Mounting set, fixture for M30 threads; stainless steel | E20873 |
|  | Angle bracket for M30 threads; stainless steel         | E10737 |

### Connection technology

|  |   |        |
|--|---|--------|
|  | Connection cable M12 / M12, 2 m, PUR, ATEX approval | EVC07A |
|  | Connection cable M12 / M12, 5 m, PUR, ATEX approval | EVC12A |



Position sensors



# KQ10 for continuous range monitoring of point levels



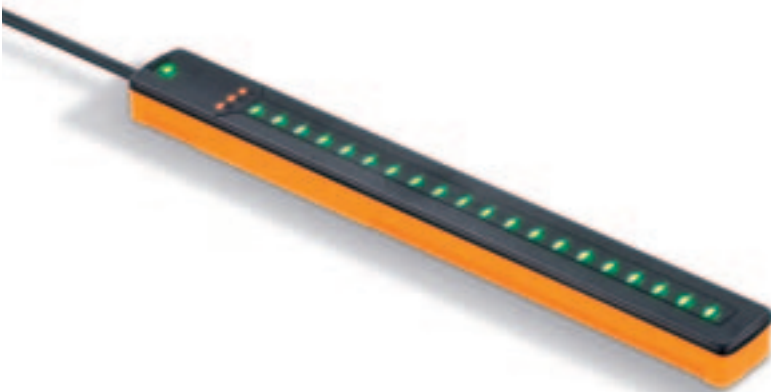

Capacitive sensors



**Continuous level monitoring from outside the process**

**No stress caused by the medium thanks to non-contact detection**

**Three point level positions in one sensor**

-  **Deposits can be detected and signalled to improve quality of the process**
-  **Several KQ10 units can be linked via IO-Link**

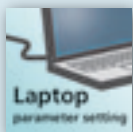

### Continuous monitoring of empty and overflow condition

The KQ10 for range monitoring can “see” through all non-metallic walls, to detect granulates or liquids without contact. Therefore, no maintenance is required. Process values of 0...100 % can continuously be transferred via IO-Link over the entire length of 250 mm without dead band. 20 LEDs display the real level inside the vessel directly at the sensor. If several KQ10 units are combined, the detection zone can be increased accordingly.



### Three switch points with just one sensor

Up to three point levels can be monitored with just one sensor where normally three sensors would be needed – and this at the same time with continuous range monitoring. Switch points and other functions such as NC / NO, hysteresis or orientation and detection zone of the sensor can be set.



| Type | U <sub>b</sub><br>[V DC] | I <sub>load</sub><br>[mA] | Current consumption<br>[mA] | Ambient temperature<br>[°C] | Protection rating / protection class | Connection | Order no. |
|------|--------------------------|---------------------------|-----------------------------|-----------------------------|--------------------------------------|------------|-----------|
|------|--------------------------|---------------------------|-----------------------------|-----------------------------|--------------------------------------|------------|-----------|

**Operating principle capacitive, without contact**

|   |                           |     |      |          |              |                                    |               |
|---|---------------------------|-----|------|----------|--------------|------------------------------------|---------------|
|  | 10...30 / 18...30 IO-Link | 200 | < 50 | -20...80 | IP 65, IP 67 | 2 m cable                          | <b>KQ1000</b> |
|  | 10...30 / 18...30 IO-Link | 200 | < 50 | -20...80 | IP 65, IP 67 | 0.1 m cable, M12 connector, 5 pins | <b>KQ1001</b> |

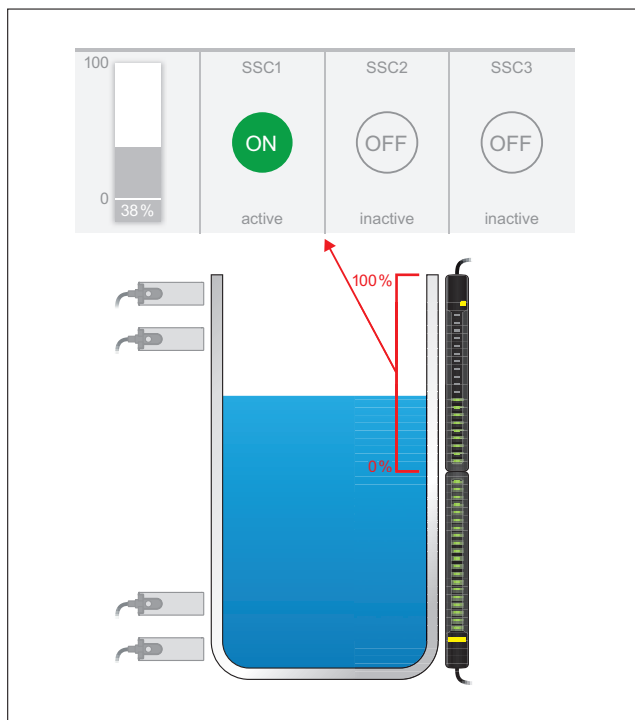

**Point level and continuous level monitoring**

As opposed to the conventional solution with two point level sensors each at the lower (empty) and upper end (overflow) of the tank, one single KQ10 comes with three switch points to indicate empty, full and overflow condition. This reduces the number of sensors and installation complexity. Moreover, it continuously measures levels in ranges of 250 mm and provides these, in addition to the switching states, as a percentage value via IO-Link.

Slight deposits on the inner walls of the tank do not impair the level detection, and they can be signalled via the switching output or IO-Link if the threshold is exceeded. This permanent condition monitoring prevents unplanned production downtime.

We reserve the right to make technical alterations without prior notice. · 09.2019

**ifm – close to you!**





**Further technical data**

|                                    |   |
|------------------------------------|---|
| Short-circuit protection           | •   |
| Protected against reverse polarity | •   |
| Switching frequency [Hz]           | 1   |
| Switching outputs                  | 3, NO/NC programmable Deposit diagnostics |
| Switching status indication        | LED orange                                |
| Operating status indication        | LED green                                 |
| Level indication                   | LED 20 x green                            |
| Type, rectangular [mm]             | 250 x 28 x 16.7                           |



**Accessories**

| Type | Description | Order no. |
|------|-------------|-----------|
|------|-------------|-----------|



**Installation**

|   |  |               |
|---|--|---------------|
|  | Adapter for flat mounting                          | <b>E12675</b> |
|  | Adapter for pipes                                  | <b>E12676</b> |
|  | Surface mount tape for KQ10                        | <b>E12677</b> |
|  | Cable tie, PA, 760 mm long, pack quantity 5 pieces | <b>E10880</b> |

**IO-Link**

|   |   |               |
|---|---|---------------|
|  | USB IO-Link master for parameter setting and analysis of units Supported communication protocols: IO-Link (4.8, 38.4 and 230 Kbits/s) | <b>ZZ1060</b> |
|  | IO-Link master with PROFINET interface  | <b>AL1100</b> |

**Connection technology**

|   |   |               |
|---|---|---------------|
|  | Connection cable, M12, 5-pole, 2 m black, PUR cable | <b>EVC058</b> |
|  | Connection cable, M12, 5-pole, 5 m black, PUR cable | <b>EVC059</b> |

For further technical details, please visit: [ifm.com](http://ifm.com)



Position sensors

# Measuring light grids for easy object monitoring in intralogistics.



Photoelectric sensors



Simple object dimensioning in intralogistics without complex programming.

High resolution for precise object detection.

- Ease of integration due to a standardised IO-Link interface.
- Selective evaluation of beams to determine the dimensions or distances between objects.

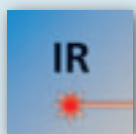

## For optimised logistic processes

The measuring light grids are perfectly suitable for monitoring intralogistics processes. An evaluation of how many and which light beams are obstructed is provided and can be used to detect whether the conveyed objects are in the correct and safe transport position.

With a beam distance of 10 millimetres, the height and width of pallets, packages and boxes, too, can be precisely detected.

## Precise monitoring with IO-Link

Five different measured values in total can be transmitted via IO-Link using the multi-beam system. The height, position, but also the contour of one or several objects can be derived from these values. What is more, diagnostic information on operating hours are determined and transmitted digitally for needs-based maintenance.





## Products

| Height Light grids [mm]                   | Height Measuring range [mm] | Number of beams | Order no.     |
|---|-----------------------------|-----------------|---------------|
| <b>Measuring light grids with IO-Link</b> |                             |                 |               |
| 213                                       | 140                         | 15              | <b>OY5100</b> |
| 663                                       | 590                         | 60              | <b>OY5103</b> |
| 1113                                      | 1040                        | 105             | <b>OY5106</b> |
| 1713                                      | 1640                        | 165             | <b>OY5110</b> |
| 2163                                      | 2090                        | 210             | <b>OY5113</b> |
| 2613                                      | 2540                        | 255             | <b>OY5116</b> |

### Common technical data

|  |        |                      |
|--|--------|----------------------|
| Operating voltage                                      | [V DC] | 24 +/- 20%           |
| Ambient temperature                                    | [°C]   | -10...55             |
| Max. range*<br>(distance from transmitter to receiver) | [m]    | 10                   |
| Protection rating,<br>Protection class                 |        | IP 65 / IP 67<br>III |
| Type of light  |        | infrared             |
| Distance of beams                                      | [mm]   | 10                   |
| Output**   |        | PNP / NPN            |
| Output   |        | H / D                |
| H = light-on / D = dark-on mode                        |        |                      |

\* with Y splitter cable EY5053, \*\* switchable via IO-Link

## Functional principle

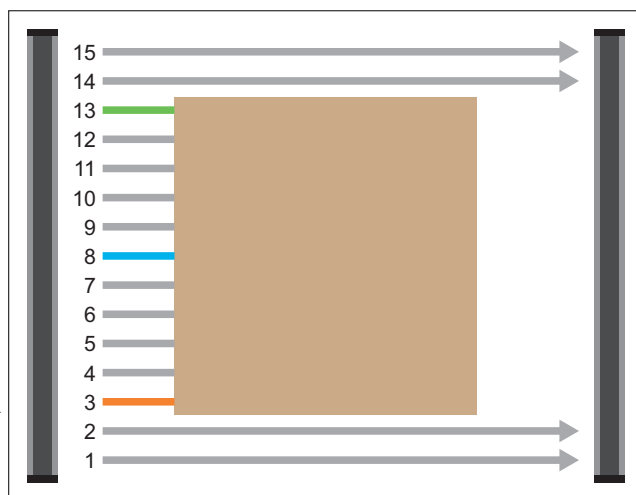

## Accessories

| Design                       | Description                                    | Order no.     |
|------------------------------|--|---------------|
| <b>Mounting accessories</b>  |  |               |
|                              | Mounting and fine adjustment unit              | <b>EY3013</b> |
|                              | Adjustable brackets                            | <b>EY3004</b> |
|                              | Laser adjustment aid                           | <b>EY3099</b> |
|                              | USB IO-Link master set                         | <b>ZZ1060</b> |
| <b>Connection technology</b> |  |               |
|                              | Socket, M12, 5 poles<br>1 m, black, PUR cable  | <b>EVC196</b> |
|                              | Socket, M12, 5 poles<br>2 m, black, PUR cable  | <b>EVC070</b> |
|                              | Socket, M12, 5 poles<br>5 m, black, PUR cable  | <b>EVC071</b> |
|                              | Socket, M12, 5 poles<br>10 m, black, PUR cable | <b>EVC072</b> |
|                              | Y splitter cable<br>Range: 1...10 m            | <b>EY5053</b> |
|                              | Y splitter cable<br>Range: 0...2 m             | <b>EY5054</b> |

## Multi-beam system with 5 measured values

The five different measured values in total are used to derive the height, position and but also the contour of one or several objects.



- FBO** First beam occupied: **3**
- LBO** Last beam occupied: **13**
- CBO** Central beam occupied: **8**
- NBO** Number of beams occupied: **11**
- NCBO** Number of consecutive beams occupied: **11**



Position sensors



# The PMD profiler: up to 10 target profiles for precise quality assurance

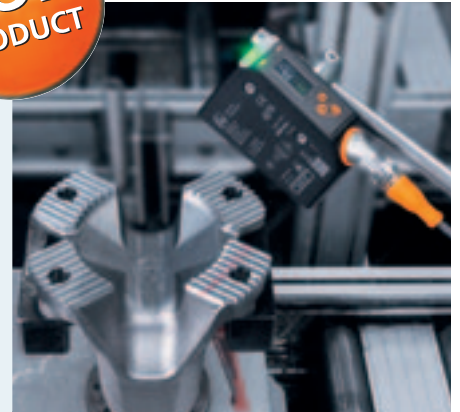

Photoelectric sensors



**Inline quality assurance checks ensure correct assembly and sorting of parts**

**Quick set-up without software**

**Colour independence and insensitivity to extraneous light ensure universal use**

**Software-supported fault analysis with profile visualisation and measured values**

**Up to 10 selectable profiles offer increased flexibility**

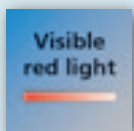
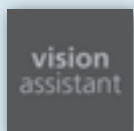
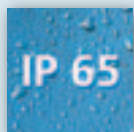

## Precise object scan for quality control

The PMD profiler compares the profile of the checked object with a taught target profile using the light section technology. The OPD101 can store up to 10 target profiles, which simplifies the checking of changing objects on the same production line. Using the sensor's 3 intuitive pushbuttons, profiles can even be taught without software. The profile to be checked can be set on the device or via software.

Thanks to its high colour tolerance and insensitivity to extraneous light, the PMD profiler can safely detect the smallest differences, e.g. between almost identical parts, even if the lighting or object colour changes. In addition, the ifm Vision Assistant can be used to visualise object profiles and read out measured values, which can indicate a displaced object, for example. This simplifies fault analysis and prevents quality loss.





| Type<br>[H, W, D mm]  | Measuring distance<br>(Z direction)<br>[mm] | Width of the measuring range<br>(X direction)<br>[mm] | Region of Interest<br>(ROI) | Storable<br>profiles | Order<br>no.  |
|---|---|---|-----------------------------|----------------------|---------------|
| <b>PMD profiler · Laser protection class 1 · M12 connector· Output function PNP/NPN</b> |   |   |                             |                      |               |
| 88 x 65 x 28.5  | 150...300                                   | 90 (for a maximum distance<br>of 300 mm)              | 1                           | 1                    | <b>OPD100</b> |
| 88 x 65 x 28.5  | 150...300                                   | 90 (for a maximum distance<br>of 300 mm)              | 1 (on unit)<br>or 2 (in VA) | 10                   | <b>OPD101</b> |

### Accessories

| Type                | Description  | Order<br>no.  |
|---------------------|--|---------------|
| <b>Installation</b> |  |               |
|                     | Mounting set OPD, 12 mm  | <b>E2D118</b> |
|                     | Mounting rod, 100 mm, Ø 12 mm, M10 thread, stainless steel   | <b>E20938</b> |
| <b>IO-Link</b>      |  |               |
|                     | USB IO-Link master for parameter setting and analysis of units<br>Supported communication protocols:<br>IO-Link (4.8, 38.4 and 230 kbits/s)  | <b>ZZ1060</b> |
|                     | IO-Link master,<br>EtherNet/IP, 4 ports  | <b>AL1320</b> |
|                     | <b>moneo configure SA</b><br>(Stand alone) licence,<br>software for online and offline parameter<br>setting of IO-Link devices including<br>maintenance and support until the end<br>of the following year | <b>QMP010</b> |

### Region of Interest: high degree of accuracy

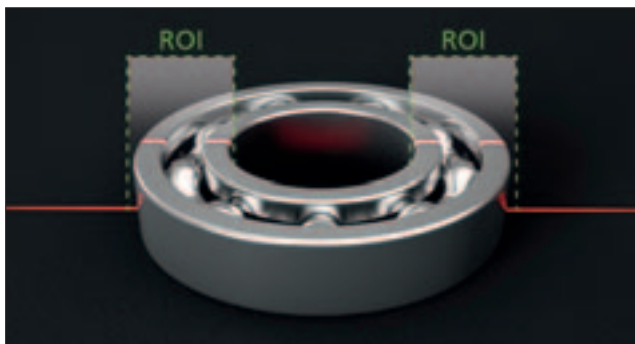

To make the determination of differences between nearly identical components even more reliable, the profile evaluation can be narrowed down to the relevant object area with green markings by using the Region of Interest function.

| Further technical data                               |        |  |
|--|--------|--|
| Operating voltage                                    | [V DC] | 10...30  |
| Resolution   | [µm]   | Z direction: 200 µm<br>X direction: 500 µm   |
| Accuracy   | [µm]   | ± 500 µm<br>(x,z dimension)  |
| Output   |        | 2x PNP/NPN<br>programmable<br>OUT1: switching output<br>(good/bad) / IO-Link<br>OUT2: switching output<br>(good/bad or<br>„ready signal“ output) |
| Protection rating,<br>protection class               |        | IP 65,<br>III  |
| Current rating                                       | [mA]   | 2 x 100  |
| Type of light / wave length                          |        | Laser light 650 nm   |
| Extraneous light immunity                            | [klx]  | 20   |
| Switching frequency                                  | [Hz]   | 5  |
| Current consumption                                  | [mA]   | < 200, 10 V DC   |
| Short-circuit protection, pulsed                     |        | •  |
| Reverse polarity protection /<br>overload protection |        | • / •  |
| Ambient temperature                                  | [°C]   | -10...55   |
| Materials  |        | Diecast zinc,<br>PPSU, ABS, PMMA,<br>PBT+PC, EPDM  |
| User interface                                       |        | TFT display,<br>3 operating keys,<br>operation display,<br>switching status indication   |

With the OPD101, 2 ROIs can be defined in the ifm Vision Assistant, e.g. to precisely detect both elevations of a ball bearing.

The function can be used in the fixed mode to verify whether the object is accurately positioned. In the floating mode, the contour comparison is variable along the laser line. It is not necessary to position the parts to be tested in exactly the same way.

### Quality assurance: definition of tolerances

The similarity between the reference and the target object is provided as a value between 0 and 100 %. The threshold function can be used to define the value from which the reference object is no longer acceptable. This allows the user to adjust the settings precisely to the corresponding application.



Position sensors



# OGD with plastic front lens: distance measurement with added safety



Laser sensors / distance sensors



**High process reliability thanks to shatterproof plastic front lens**

**2 in 1: simultaneous output of distance value and reflectivity**

**Identification and sorting of objects based on reflectivity**

**Process values shown on 2-colour display and sent via IO-Link**

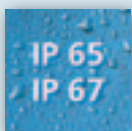
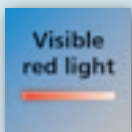

## Everything under control thanks to OGD Reflectivity with plastic lens

The OGD Reflectivity features a switching output for the reflectivity value in addition to providing distance information. This increases the reliability of process control: For example, it not only detects whether toppings have been added to a deep-frozen product, but also determines whether the correct topping has been used based on its reflectivity.

In addition, the OGD Reflectivity now features a plastic front lens to eliminate the possibility of glass splintering, especially in food applications. This not only ensures reliable process control, but also a high degree of process safety. All parameters of the sensor can be set as usual using three pushbuttons and are clearly indicated on the two-colour display. Parameter setting and reading is also possible via IO-Link.



| Measuring range [mm] | Background suppression [m] | Output | Laser protection class | Spot Ø at max. range [mm] | Unit of measurement | Order no. |
|----------------------|----------------------------|--------|------------------------|---------------------------|---------------------|-----------|
|----------------------|----------------------------|--------|------------------------|---------------------------|---------------------|-----------|

**Photoelectric distance sensor · M12 connector**

|            |       |     |   |   |                       |               |
|------------|-------|-----|---|---|-----------------------|---------------|
| 80...1,500 | ...20 | PNP | 1 | 5 | cm, refl (selectable) | <b>OGD583</b> |
|------------|-------|-----|---|---|-----------------------|---------------|

**Accessories**

| Type | Description | Order no. |
|------|-------------|-----------|
|------|-------------|-----------|

**Installation**

|  |   |               |
|--|---|---------------|
|  | Mounting set for clamp mounting, M10 thread, diecast zinc           | <b>E20718</b> |
|  | Mounting set for clamp mounting, M10 thread, stainless steel        | <b>E20870</b> |
|  | Mounting set for clamp mounting, Ø 12 mm, diecast zinc              | <b>E20836</b> |
|  | Mounting set for clamp mounting, Ø 12 mm, stainless steel           | <b>E21207</b> |
|  | Mounting rod, 100 mm, Ø 12 mm, M10 thread, stainless steel          | <b>E20938</b> |
|  | Cube for mounting on an aluminium profile, M10 thread, diecast zinc | <b>E20951</b> |

**IO-Link**

|  |  |               |
|--|--|---------------|
|  | USB IO-Link master for parameter setting and analysis of units<br>Supported communication protocols:<br>IO-Link (4.8, 38.4 and 230 kbits/s)  | <b>ZZ1060</b> |
|  | Memory plug, parameter memory for IO-Link sensors  | <b>E30398</b> |
|  | IO-Link master with PROFINET interface   | <b>AL1100</b> |
|  | <b>moneo configure SA</b><br>(Stand alone) licence, software for online and offline parameter setting of IO-Link devices including maintenance and support until the end of the following year | <b>QMP010</b> |

**Connection technology**

|  |                                  |               |
|--|----------------------------------|---------------|
|  | M12 socket, 2 m black, PUR cable | <b>EVC001</b> |
|  | M12 socket, 5 m black, PUR cable | <b>EVC002</b> |
|  | M12 socket, 2 m black, PUR cable | <b>EVC004</b> |
|  | M12 socket, 5 m black, PUR cable | <b>EVC005</b> |

**Further technical data**

|   |         |   |
|---|---------|---|
| Operating voltage                                 | [V DC]  | 10...30   |
| Type of light / wave length                       |         | Laser light 650 nm                              |
| Laser protection class                            |         | 1   |
| Output  |         | L / D selectable                                |
| L = Light-on / D = Dark-on mode                   |         |   |
| Protection rating, protection class               |         | IP 65 / IP 67 III                               |
| Extraneous light immunity                         | [klx]   | 10  |
| Switching status indication                       | LED     | 2 x yellow                                      |
| Switching frequency                               | [Hz]    | 11  |
| Current rating                                    | [mA]    | 2 x 100   |
| Current consumption                               | [mA]    | 75  |
| Short-circuit protection, pulsed                  |         | •   |
| Reverse polarity protection / overload protection |         | • / •   |
| Ambient temperature                               | [°C]    | -25...50  |
| Materials   | Housing | Stainless steel (316Ti/1.4404); ABS; PPSU; PMMA |
|   | Lens    | PMMA  |

**Dimensions**

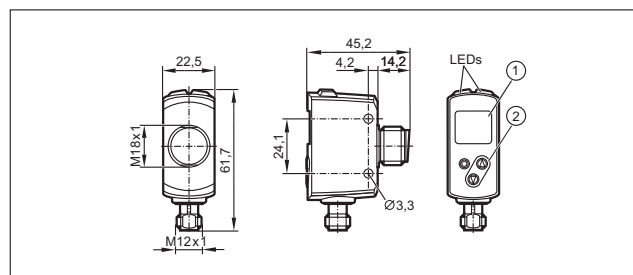

- 1) Alphanumeric display, 3 digits
- 2) Programming buttons

**Wiring diagram**

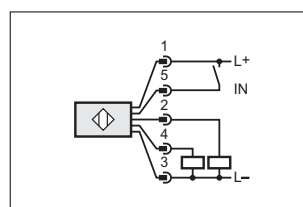

We reserve the right to make technical alterations without prior notice. · 11.2020



Position sensors

# Always know where you stand: position feedback for ball valves



Valve feedback systems



The ball valve's type and position are directly visible in the plant

Direct visualisation thanks to the flexible position indicator for T-port, L-port, and Y-port directional flow valves

Free angular adjustment of the targets reduces type versions and stock-keeping

Universally applicable on drives according to VDI/VDE 3845



## Flexible position feedback

The switching cams are mounted on ball valves for position feedback. Adjustable damping elements allow the pucks to be used in both standard and individual position feedback applications.

## Position of the ball valve at a glance

The uniqueness of this puck is the adjustable position indicator on the top, which can be flexibly adapted to L-port and, via an additional indicator element, also to T-port and Y-port valves. This makes it possible to clearly visualise the position of the ball valve directly in the system.



The flow direction can be clearly seen via the position indicator

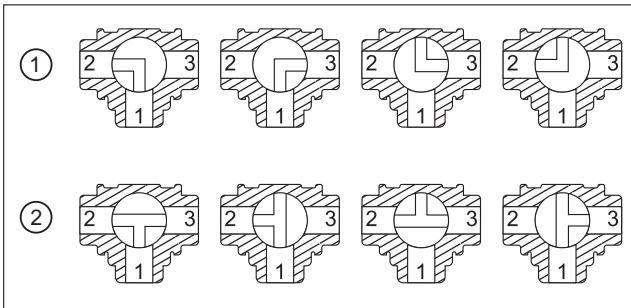

1) L-port valve  
2) T-port valve



The user can set the position indicator according to the type of ball valve (I, L, T or Y)



The position of the ball valve can be seen directly in the plant



### Target pucks

| Mounting dimensions [X / Y mm] | Height of the actuator shaft [Z mm] | Description                   | Order no. |
|--------------------------------|-------------------------------------|-------------------------------|-----------|
| <b>Ø shaft stub: ≤ 58 mm</b>   |                                     |                               |           |
| 80 / 30                        | 30                                  | Puck basic                    | E12724    |
| 80 / 30                        | 30                                  | Puck adjustable               | E12725    |
| -                              | -                                   | Multi-cover indicator for T/Y | E12726    |
| <b>Ø shaft stub: ≤ 38 mm</b>   |                                     |                               |           |
| 80 / 30                        | 30                                  | Puck adjustable               | E12516    |
| 80 / 30                        | 30                                  | Puck basic                    | E12517    |

### Dimensions

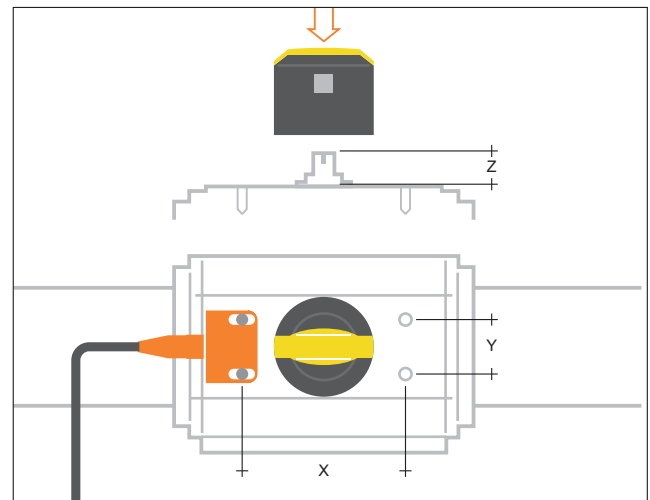

### Accessories

| Design  | Description   | Order no. |
|---|---------------|-----------|
|  | Spacer, 10 mm | E12526    |

We reserve the right to make technical alterations without prior notice. · 04.2021





Sensors for motion control

# A safe choice: draw-wire mechanisms for encoders.



## Encoders



**Precise position detection including over long distances.**

**High operational reliability thanks to robust mechanical construction even under permanent strain.**

**Mechanically compatible across manufacturers, for encoders with synchro flange.**

**Compact design even with rope spans up to 15 m.**

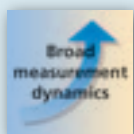
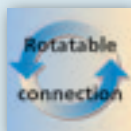
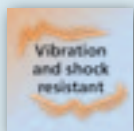

### **Exact positioning including over long distances**

Draw-wire mechanisms for encoders are the ideal choice when positions must be accurately determined over straight distances. Examples of use range from short distances, for example with scissor lifts or fork lift trucks, to long distances, such as those covered by trolleys on crane booms or transport systems in high-bay warehouses.

### **Solid connection, robust against external influences**

Advantage of the pulley principle: there is an uninterrupted connection between the encoder and the moving object. Adverse effects on distance detection e.g. caused by dirt with optical distance measurement, are mostly eliminated.

The mechanical components are designed for industrial, long-lasting use with up to 1 million pulls.



## Draw-wire mechanisms

| Design | Dimensions [mm] | Linearity [%] | Housing type/<br>Housing material           | Rope spans up to* [m] | Order no.     |
|--------|-----------------|---------------|---|-----------------------|---------------|
|        | 80 x 48 x 82    | ± 0.02        | cylindrical /<br>metal, aluminium, anodised | 1.5                   | <b>E61439</b> |
|        | 60 x 57 x 89    | ± 0.1         | cylindrical /<br>PA                         | 2.4                   | <b>E61440</b> |
|        | 78 x 40 x 75    | ± 0.01        | rectangular /<br>die-cast zinc, plastic     | 3                     | <b>E61441</b> |
|        | 115 x 103 x 115 | ± 0.01        | rectangular /<br>aluminium, anodised        | 5                     | <b>E61442</b> |

\* draw wire mechanisms with other lengths on request

## Encoders

| Draw wire mechanisms in combination with encoder |                                    |                    |                     |                |                       |                      |
|--|------------------------------------|--------------------|---------------------|----------------|-----------------------|----------------------|
|  |                                    |                    |                     |                |                       |                      |
|  |                                    |                    |                     |                |                       |                      |
| <b>RMU300</b>                                    | <b>RU3100</b>                      | <b>RM9007</b>      | <b>RM3006</b>       | <b>RMU400</b>  | <b>RMU100</b>         | <b>RMU200</b>        |
| IO-Link<br>multiturn, 31 bits                    | Incremental<br>(IO-Link), 3 tracks | CANopen<br>24 bits | PROFIBUS<br>25 bits | SSI<br>24 bits | Analogue<br>4...20 mA | Analogue<br>0...10 V |

These encoder versions solve the majority of applications. In principle, other encoders with 58 mm diameter, synchro flange and 6 mm shaft diameter can also be used with the draw wire mechanisms. You will find further encoders at ifm.com.

## Accessories

| Description                          | Order no.     |
|--------------------------------------|---------------|
| Pulley                               | <b>E61445</b> |
| IO-Link master Profinet, 4 ports     | <b>AL1100</b> |
| IO-Link master, EtherNet/IP, 4 ports | <b>AL1120</b> |

## Connection technology

| Description                              | Order no.     |
|--|---------------|
| M12 socket, 5-pole, 5 m black, PUR cable | <b>EVC545</b> |
| M12 socket, 8-pole, 5 m black, PUR cable | <b>E12403</b> |

We reserve the right to make technical alterations without prior notice. · 04.2021



# Decentralised and smart monitoring of rotating machines



Systems for signalling and indication



Mini display with speed monitoring function for direct mounting on the sensor

On-site speed display with colour change (red/green)

Two adjustable limit values, each with its own switching output

- IO-Link enables parameter setting outside the danger zone
- Transmission of the current speed to the controller via IO-Link

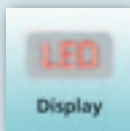

## Transforms any sensor into a speed monitor

Whether inductive, capacitive or photoelectric sensor: This small device transforms any pulse-generating sensor into a speed monitor. The mini display with speed monitoring function is either screwed directly onto the sensor using an M12 connection or installed in the field. Two adjustable limit values, each with its own switching output, as well as a display with altering red/green indication signal if the current value is above or below the defined speed range.

The unit is conveniently set via IO-Link or using the buttons on the device. The speed value can also be transmitted to the controller via the digital communication protocol.

This makes the speed monitor plug an inexpensive and flexible solution for decentralised monitoring of conveyor belts, screw conveyors, fans, centrifuges, separators, etc.





## Dimensions

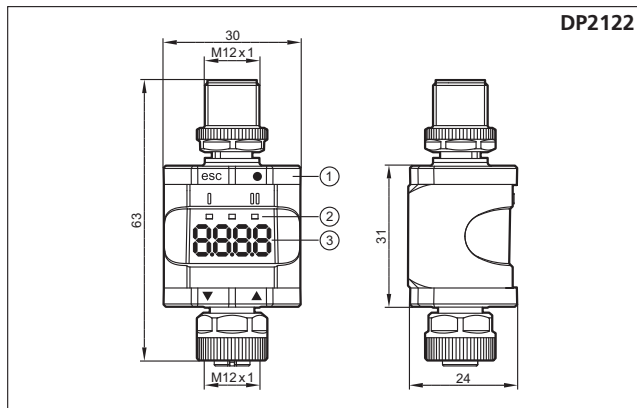

- 1) Push ring
- 2) LEDs
- 3) Display

## Wiring diagram

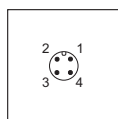

### M12, 4-pole male connector

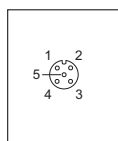

- Pin 1: L+ / supply voltage
- Pin 2: OUT2 / digital output 2
- Pin 3: L- / supply voltage
- Pin 4: OUT1 / IO-Link (C/Q)



### M12, 5-pole female connector

- Pin 1: L+
- Pin 2: enable input
- Pin 3: L-
- Pin 4: IN1 / digital input 1
- Pin 5: not used

## Accessories

| Type  | Description  | Order no.     |
|---|--|---------------|
|  | Mounting clip, robust design for use in harsh industrial environments  | <b>E89208</b> |
|  | 1-port IO-Link master (for connecting IO-Link sensors to a PC via USB) | <b>AL1060</b> |

## Technical data

| Mini display with speed monitoring function | Order no. DP2122                   |
|---|------------------------------------|
| Nominal voltage                             | [V DC] 24                          |
| Input frequency                             | [Hz] 2000                          |
| Current consumption                         | [mA] 30...380 (24 V DC, full load) |
| Inputs                                      | 2 x digital                        |
| Outputs                                     | 2 x digital                        |
| Voltage range                               | [V DC] 18...30                     |
| Output function                             | NO / NC (configurable)             |
| Current rating per output                   | [mA] 50 (pin 4) / 100 (pin 2)      |
| Ambient temperature                         | [°C] -25...60                      |
| Storage temperature                         | [°C] -25...60                      |
| Protection rating                           | IP 67                              |
| Communication interface                     | IO-Link                            |
| Operation indication                        | LED 1 x green                      |
| Output indication                           | LED 2 x yellow                     |
| Connection                                  | M12 connection                     |

## Applications

Especially in the field of conveying technology the speed sensors can be used in various applications, for example, to monitor belt conveyors or bucket elevators. Here they are typically used to monitor underspeed, blockage or standstill.

## Advantages

The mini display incorporates the complete speed monitoring. The switch points and other parameters can be set directly on the display. In addition, IO-Link provides remote information about the current speed or the switch point and the configuration of important parameters such as the start-up delay time.

## Operating principle

The sensor is damped by passing cams or other metallic targets and transmits the pulses to the display. On the basis of the time interval between the damping operations, the evaluation calculates the period duration or the frequency (actual rotational speed value) and compares it to the set switch point (preset value). The output is switched during the start-up delay and when the rotational speed exceeds the set switching value.

The mini display signals over- and underspeed and switch-off of the output.



# Accelerate pallet detection using 3D cameras



3D sensors



For all standard pallets with two pallet pockets

Position accuracy of  $\pm 1\text{cm}$

Ranges up to 4 m

Detection time  $< 1\text{ s}$

Communication via Ethernet or CAN

Support on GitHub

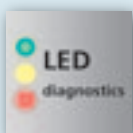
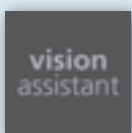

### Powerful

The PDS pallet detection system is a tried-and-tested software solution for faster, fully automatic and position-independent detection of standard pallet types with two pockets. In combination with the O3D hardware, pallet position detection is extremely fast and accurate. This constitutes a significant reduction of the overall cycle time of pallet detection in autonomous and semi-autonomous pallet handling vehicles.

### Efficient

Even in adverse environmental conditions, the sophisticated software solution will lead the lift fork reliably to its destination by means of the 3D point cloud of the ToF camera. The Pallet Detection System directly impacts the performance of the autonomous and semi-autonomous vehicles by increasing the speed of detecting the pallet position without sacrificing the quality of the detection.



| Interface  | Type of sensor  | Material<br>Front pane / LED window | Protection rating /<br>Protection class | Angle of<br>aperture<br>[°] | Max.<br>field of view size<br>[m] | Order<br>no.  |
|--|-----------------|-------------------------------------|---|-----------------------------|-----------------------------------|---------------|
| <b>PMD 3D sensors · O3D type · M12 connector · housing material: Aluminium</b> |                 |                                     |   |                             |                                   |               |
| Ethernet   | PMD 3D ToF chip | Gorilla glass / polyamide           | IP 65, IP 67 / III                      | 40 x 30                     | 2.61 x 3.47                       | <b>O3DP01</b> |
| CAN  | PMD 3D ToF chip | Gorilla glass / polyamide           | IP 65, IP 67 / III                      | 40 x 30                     | 2.61 x 3.47                       | <b>O3DP21</b> |
| Ethernet   | PMD 3D ToF chip | Gorilla glass / polyamide           | IP 65, IP 67 / III                      | 60 x 45                     | 3.75 x 5.00                       | <b>O3DP03</b> |
| CAN  | PMD 3D ToF chip | Gorilla glass / polyamide           | IP 65, IP 67 / III                      | 60 x 45                     | 3.75 x 5.00                       | <b>O3DP23</b> |

### Technical data Pallet detection

|                    |      |             |
|--------------------|------|-------------|
| Operating distance | [m]  | 0.3...2 (4) |
| Position accuracy  | [cm] | ±1          |
| Detection time     | [s]  | < 1         |
| Angle of approach  | [°]  | +12 / -12   |

### Accessories

| Housing | Description | Order no. |
|---------|-------------|-----------|
|---------|-------------|-----------|

#### Mounting accessories

|  |                        |               |
|--|------------------------|---------------|
|  | Mounting set for O3D   | <b>E3D301</b> |
|  | Dissipators            | <b>E3D302</b> |
|  | Double cooling element | <b>E3D304</b> |
|  | Heat conductor         | <b>E3D303</b> |

#### Connection technology

|  |  |               |
|--|--|---------------|
|  | Ethernet, cross-over patch cable, 2 m, PVC cable, M12 / RJ45 | <b>E11898</b> |
|  | Ethernet, jumper cable, 2 m, PVC cable, M12 / M12            | <b>E21138</b> |
|  | Socket, M12, 2 m black, PUR cable, 8-pole                    | <b>E11950</b> |
|  | Socket, M12, 4-pole, 2 m black, PUR cable                    | <b>EVC001</b> |
|  | CAN connection cable, M12 socket, 2 m purple, PUR cable      | <b>E11596</b> |
|  | CAN connection cable, M12 socket, 5 m purple, PUR cable      | <b>E11597</b> |

### Further technical data

|                                       |        |   |
|---------------------------------------|--------|---|
| Operating voltage                     | [V DC] | 20.4...28.8   |
| Current consumption                   | [mA]   | < 2400 peak current pulsed;<br>typ. mean value 420                              |
| Current rating (per switching output) | [mA]   | 100   |
| Short-circuit protection, pulsed      |        | •   |
| Overload protection                   |        | •   |
| Ambient temperature                   | [°C]   | -10...50  |
| Real chip resolution                  |        | 25,000 / 100,000  |
| Resulting resolution                  |        | 176 x 132 pixels  |
| Function display                      | LED    | 2 x yellow, 2 x green   |
| Illumination                          |        | 850 nm, infrared  |
| Immunity to extraneous light          | [klx]  | 8<br>(up to 100 klx possible with reduced measuring accuracy and repeatability) |
| Trigger                               |        | external;<br>24 V PNP / NPN according to IEC 61131-2 type 3                     |
| Switching inputs                      |        | 2<br>(configurable), 24 V PNP / NPN according to IEC 61131-2 type 3             |
| Switching outputs digital             |        | 3<br>(configurable), 24 V PNP / NPN, according to IEC 61131-2                   |
| Switching outputs analogue            |        | 1<br>(can be configured as current output 4...20 mA or voltage output 0...10 V) |
| Parameter setting interface Ethernet  |        | 10 Base-T / 100 Base-TX   |
| Possible parameter settings           |        | via PC / notebook   |
| Dimensions (H, W, D)                  | [mm]   | 72 x 67.1 x 95  |

We reserve the right to make technical alterations without prior notice. · 04.2020

**ifm** – close to you!

For further technical details, please visit: [ifm.com](http://ifm.com)



Industrial imaging

# Collision protection for automated guided vehicle systems



3D cameras



**3D camera also detects obstacles above the detection zone of conventional safety laser scanners**

**The system optimises the collision warning based on speed and steering angle**

**Safe detection even in case of difficult obstacles**

**Three-dimensional detection in driving direction: 60° x 45°**

**Unaffected by ambient light**

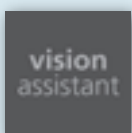

## Powerful obstacle recognition

Collisions of automated guided vehicles in indoor areas with protruding or suspended objects and other obstacles must be avoided under all circumstances. For this purpose, ifm offers the ODS (Obstacles Detection System) collision protection system, which consists of a PMD 3D camera and intelligent integrated software. Supplementing the mandatory safety laser scanner, it monitors the manoeuvring range in three dimensions and can even detect obstacles positioned higher up, such as forklift arms, high-speed doors or crane hooks.

## Intelligent prediction

The unit features three collision warning levels. Both the speed and the steering angle are taken into account. This prevents unnecessary braking and provides optimum protection during all vehicle manoeuvres.



| Interface | Type of sensor | Material<br>Front lens / LED window | Protection rating/<br>protection class | Angle<br>of aperture<br>[°] | Max.<br>field of view size<br>[m] | Order<br>no. |
|-----------|----------------|-------------------------------------|--|-----------------------------|-----------------------------------|--------------|
|-----------|----------------|-------------------------------------|--|-----------------------------|-----------------------------------|--------------|

**PMD 3D camera · O3D type · M12 connector · housing material: aluminium  
Obstacle detection for collision avoidance**

Ethernet    PMD 3D ToF chip    Gorilla glass / PA    IP 65, IP 67 / III    60 x 45    3.2 x 4.52    **O3DC02**

### Technical data Collision avoidance

|   |      |  |
|---|------|--|
| Operating distance                        | [m]  | 0.2...2 (4)  |
| Response time                             | [s]  | < 1  |
| Minimum height of objects<br>above ground | [cm] | 15   |
| Typ. objects                              |      | Boxes,<br>fork arms (lateral),<br>bicycles, AGVs,... |

### Further technical data

|   |        |  |
|---|--------|--|
| Operating voltage                       | [V DC] | 20.4...28.8  |
| Current consumption                     | [mA]   | < 2400<br>peak current pulsed;<br>typ. mean value<br>1600                                |
| Short-circuit protection, pulsed        |        | •  |
| Overload protection                     |        | •  |
| Ambient temperature                     | [°C]   | -10...50   |
| Real chip resolution                    |        | 25,000 /<br>100,000  |
| Resulting resolution                    |        | 176 x 132<br>pixels  |
| Function display                        | LED    | 2 x yellow,<br>2 x green   |
| Lighting                                |        | 850 nm,<br>infrared  |
| Immunity to extraneous light            | [klx]  | 8<br>(up to 100 klx possible<br>with reduced<br>measuring accuracy and<br>repeatability) |
| Parameter setting interface<br>Ethernet |        | 10 Base-T /100 Base-TX   |
| Parameter setting options               |        | Via PC /<br>notebook   |
| Dimensions (H, W, D)                    | [mm]   | 72 x 65 x 95   |

### Accessories

| Type | Description | Order<br>no. |
|------|-------------|--------------|
|------|-------------|--------------|

#### Mounting accessories

|  |                        |               |
|--|------------------------|---------------|
|  | Mounting set for O3D   | <b>E3D301</b> |
|  | Cooling element        | <b>E3D302</b> |
|  | Double cooling element | <b>E3D304</b> |
|  | Heat conductor         | <b>E3D303</b> |

#### Connection technology

|  |   |               |
|--|---|---------------|
|  | Ethernet, cross-over patch cable,<br>2 m, PVC cable, M12 / RJ45 | <b>E11898</b> |
|  | Ethernet, jumper cable,<br>2 m, PVC cable, M12 / M12            | <b>E21138</b> |
|  | Socket, M12,<br>2 m black, PUR cable, 8-pole                    | <b>E11950</b> |

We reserve the right to make technical alterations without prior notice. · 11.2020



# Flexible LED strip for illumination and signalling.



## Illumination



LEDs in RGB and white can be controlled directly via digital inputs.

Extremely robust, fully potted design with protection rating IP 68.

Bent or straight installation.

Powerful LEDs for high light yield.

Different length versions available.



### Illumination and signalling all-in-one.

LED strips cannot only be used as machine light but also indicate the machine status with different light colours. The LED strips are available in different lengths and flexible in use. They can be quickly and securely fastened with optional aluminium profiles so that even out-of-the way corners are lit up without casting shadows. Their robust design with protection rating IP 68 allows for a wide range of applications.

### Enough colour

The LED strips consist of powerful LEDs in the colours RGB and white. Triggering is via four digital inputs that can be used to produce the colours Red, Yellow, Green, Blue, Cyan and Purple, as well as pure white light. Indeed any colour shade is possible with using pulse width modulation control.





| Design                | Dimensions [mm]   | Illuminated area [mm] | Current consumption [mA] | Luminous flux [lm]                                   | Order no.     |
|-----------------------|-------------------|-----------------------|--------------------------|--|---------------|
| <b>LED strip RGBW</b> |                   |                       |                          |  |               |
|                       | 77.5 x 14.2 x 4.5 | 62.5                  | 100                      | red: 12.6 / green: 23.6 / blue: 4.6 / white: 35.6    | <b>DV1000</b> |
|                       | 265 x 14.2 x 4.5  | 250                   | 400                      | red: 25.3 / green: 67.2 / blue: 9.2 / white: 71.3    | <b>DV1001</b> |
|                       | 515 x 14.2 x 4.5  | 500                   | 800                      | red: 50.6 / green: 94.4 / blue: 18.5 / white: 142.6  | <b>DV1002</b> |
|                       | 765 x 14.2 x 4.5  | 750                   | 1200                     | red: 75.9 / green: 161.6 / blue: 27.7 / white: 213.9 | <b>DV1003</b> |
|                       | 1015 x 14.2 x 4.5 | 1000                  | 1600                     | red: 101.2 / green: 188.8 / blue: 37 / white: 285.2  | <b>DV1004</b> |

## Accessories

| Design                      | Description              | Order no.     |
|-----------------------------|--------------------------|---------------|
| <b>Mounting accessories</b> |                          |               |
|                             | Mounting profile 62.5 mm | <b>E89030</b> |
|                             | Mounting profile 250 mm  | <b>E89031</b> |
|                             | Mounting profile 500 mm  | <b>E89032</b> |
|                             | Mounting profile 750 mm  | <b>E89033</b> |
|                             | Mounting profile 1000 mm | <b>E89034</b> |
|                             | Mounting clip            | <b>E70442</b> |

## Connection technology

|  |  |               |
|--|--|---------------|
|  | Y cable for connection to output modules | <b>EVC854</b> |
|--|--|---------------|

## Common technical data

|                                    |         |                                  |
|------------------------------------|---------|----------------------------------|
| Operating voltage                  | [V DC]  | 21.6...26.4                      |
| Nominal voltage                    | [V DC]  | 24<br>(according to SELV / PELV) |
| Colour temperature                 | [K]     | 4,000                            |
| Typ. life cycle                    | [h]     | 30,000                           |
| Input circuit digital inputs       | [V PNP] | 24                               |
| Input current high                 | [mA]    | 10                               |
| Ambient temperature                | [°C]    | -20...45                         |
| Max. permissible relative humidity | [%]     | 90                               |
| Max. height above sea level        | [m]     | 4,000                            |
| Protection                         |         | IP 68                            |
| Degree of soiling                  |         | 2                                |

## Diagrams and graphs

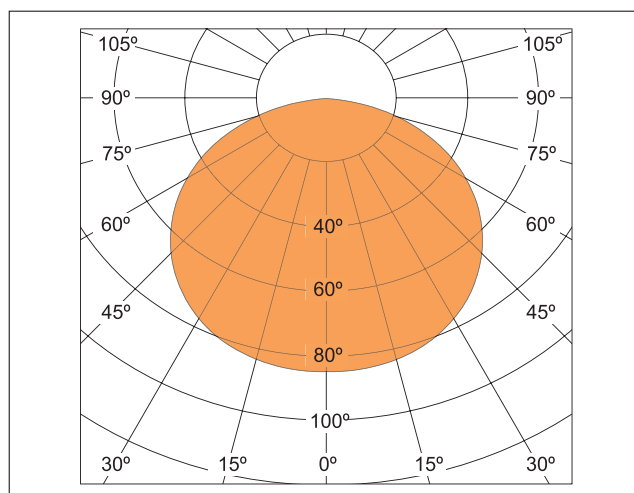

For further technical details, please visit: [ifm.com](http://ifm.com)



# Ultra-flat backlight for vision sensors



Bit detection using a backlight

## Illumination units



**Powerful permanent light for contour and position verification**

**Longer life through pulse operation**

**Homogeneous illumination with red or infrared light**

**Space-saving installation – only 9.8 mm overall height**

**Three different illuminated area sizes available**

**Industrially-compatible M12 connector**



### Perfect illumination

These powerful backlights create homogeneous light, ensuring optimal, shadow-free illumination of the objects to be inspected. The outer contours are strongly highlighted by the background illumination and can be optimally analysed by a vision sensor. The sensor verifies contours and positions rapidly and reliably. The backlight can be operated in permanent or pulsed mode. In addition to many other advantages, this especially results in a longer life of the unit.

### Ultra-flat design

Due to its extremely flat design with an overall height of only 9.8 mm, ifm's new generation of backlights allows for a very space-saving installation. Optional mounting sets ensure quick and easy fastening.





| Type                                       | Active illuminated area [mm] | Current consumption [mA] | Length [mm] | Width [mm] | Height [mm] | Weight [g] | Order no.     |
|--|------------------------------|--------------------------|-------------|------------|-------------|------------|---------------|
| <b>Backlight · Light colour red 617 nm</b> |                              |                          |             |            |             |            |               |
|  | 25 x 25                      | < 80                     | 70.5        | 33.4       | 9.5         | 58         | <b>O2D940</b> |
|  | 50 x 50                      | < 205                    | 105         | 81         | 9.8         | 160        | <b>O2D942</b> |
|  | 100 x 100                    | < 410                    | 155         | 133        | 9.8         | 347        | <b>O2D944</b> |

|   |           |       |      |      |     |     |               |
|---|-----------|-------|------|------|-----|-----|---------------|
| <b>Backlight · Light colour infrared 875 nm</b> |           |       |      |      |     |     |               |
|   | 25 x 25   | < 95  | 70.5 | 33.4 | 9.5 | 58  | <b>O2D941</b> |
|   | 50 x 50   | < 325 | 105  | 81   | 9.8 | 160 | <b>O2D943</b> |
|   | 100 x 100 | < 620 | 155  | 133  | 9.8 | 347 | <b>O2D945</b> |

| Type                        | Description                                  | Order no.     | Further technical data              |  |
|-----------------------------|--|---------------|-------------------------------------|--|
| <b>Mounting accessories</b> |  |               |                                     |  |
|                             | Mounting set for backlight 25 x 25 mm        | <b>E2D107</b> | Operating voltage [V DC]            | 24   |
|                             | Mounting set for backlight 50 x 50 mm        | <b>E2D108</b> | Trigger [V DC]                      | 5...24   |
|                             | Mounting set for backlight 100 x 100 mm      | <b>E2D109</b> | Protection rating, protection class | IP 54, III   |
|                             | Connection piece for clamps, stainless steel | <b>E21076</b> | Ambient temperature [°C]            | -10...50   |
|                             | Clamp, stainless steel, Ø 12 mm              | <b>E21110</b> | Connection                          | Connection cable 0.3 m, PUR with M12 connector, gold-plated contacts |
|                             | Rod, 150 mm, Ø 12 mm, stainless steel        | <b>E21111</b> | Housing materials                   | Anodised aluminium, illuminated area: glass                          |
|                             | Rod, 200 mm, Ø 12 mm, stainless steel        | <b>E21112</b> |                                     |  |
|                             | Rod, 300 mm, Ø 12 mm, stainless steel        | <b>E21113</b> |                                     |  |

### Homogeneity

In industrial imaging applications, the use of backlights is essential to ensure fast and reliable object recognition. Especially with flat lighting concepts, creating a homogeneous illuminated area poses a challenge.

The new powerful backlights from ifm improve the lighting of application backgrounds. This results in shorter exposure times of industrial cameras and reduces the influence of extraneous light.

### Wiring diagram

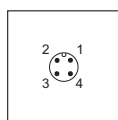

M12 connector  
 Pin 1: 24 V DC  
 Pin 2: N.C.  
 Pin 3: 0 V  
 Pin 4: on / trigger

We reserve the right to make technical alterations without prior notice. · 04.2021



# Simply reliable: fail-safe sensors for mobile machines



## Fail-safe inductive sensors



**Safety sensor enters the safe state, logic "0", as soon as the sensor is damped**

**Installation costs and time reduced as the target is only required in the end position**

**Comprehensive self-diagnostics for maintenance-free continuous operation**

**Designed for use in harsh environments**

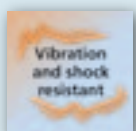
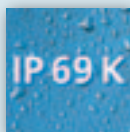
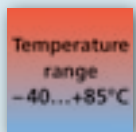
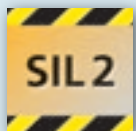

### Target activates safe state

The fail-safe sensors switch into the safe state as soon as the target is detected inside the safe switch-off distance. The safety-related function is inverted when compared to the previous fail-safe sensors. This function is ideal in applications such as the protection of crane installations or industrial robots because the targets only need to be mounted at the end positions. Both the number of metallic targets and the installation complexity are considerably reduced.

### Perfectly equipped for mobile use

Thanks to the robust design the sensor is perfectly suited for use in mobile machines. Applications on mobile machines such as monitoring whether supports are fully extended or waste bins gripped in the right way. Neither strong vibration nor extreme temperatures and cleaning processes affect the function of the fail-safe sensor in any way.



| Design | Housing length [mm] | Installation | Enable zone [mm] | Safe switch-off distance [mm] | Order no. |
|--------|---------------------|--------------|------------------|-------------------------------|-----------|
|--------|---------------------|--------------|------------------|-------------------------------|-----------|

**M12 connector · 4 poles**

|           |    |           |        |        |               |
|-----------|----|-----------|--------|--------|---------------|
| M12 x 1   | 60 | non flush | > 6.0  | < 3.0  | <b>GF854S</b> |
| M18 x 1   | 60 | flush     | > 7.5  | < 4.0  | <b>GG855S</b> |
| M18 x 1   | 60 | non flush | > 11.5 | < 6.5  | <b>GG854S</b> |
| M30 x 1.5 | 65 | flush     | > 14.5 | < 8.0  | <b>GI855S</b> |
| M30 x 1.5 | 65 | non flush | > 21.5 | < 12.0 | <b>GI854S</b> |

**Connection technology**

| Design | Description                                       | Order no.     |
|--------|---|---------------|
|        | Socket, M12, 2 m, PUR cable, halogen-free, black  | <b>EVM001</b> |
|        | Socket, M12, 5 m, PUR cable, halogen-free, black  | <b>EVM002</b> |
|        | Socket, M12, 10 m, PUR cable, halogen-free, black | <b>EVM003</b> |
|        | Socket, M12, 2 m, PUR cable, halogen-free, black  | <b>EVM004</b> |
|        | Socket, M12, 5 m, PUR cable, halogen-free, black  | <b>EVM005</b> |
|        | Socket, M12, 10 m, PUR cable, halogen-free, black | <b>EVM006</b> |

**Further technical data**

|                                   |                                      |
|-----------------------------------|--------------------------------------|
| Safety-related function           | Safe state when properly damped      |
| Operating mode                    | Permanent operation                  |
| ISO 13849-1                       | Category 2 PL d                      |
| IEC 61508                         | SIL 2                                |
| IEC 62061                         | SIL 2 cl 2                           |
| Applications                      | Use in mobile and harsh applications |
| Operating voltage [V DC]          | 8...32                               |
| Protection rating                 | IP 65, IP 66, IP 67, IP 68, IP 69K   |
| Protection class                  | III                                  |
| Electrical design                 | PNP                                  |
| Output function                   | 2 x OSSD, CB 24 I / C 1              |
| Switching status indication [LED] | yellow (4 x 90°)                     |
| Permanent current rating [mA]     | 50                                   |
| Ambient temperature [°C]          | -40...85                             |

**Dimensions**

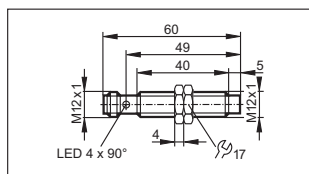

GF854S

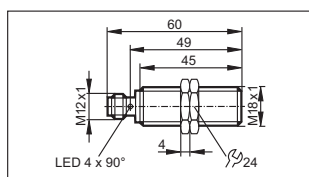

GG855S

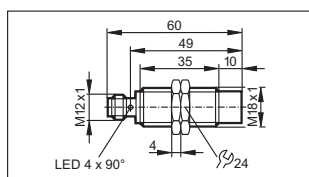

GG854S

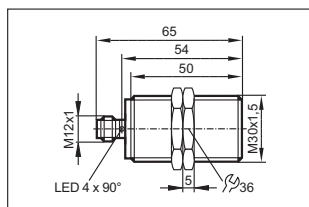

GI855S

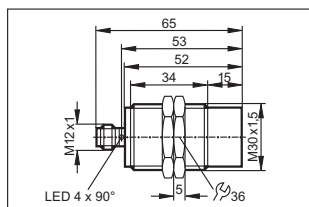

GI854S

**Wiring diagram**

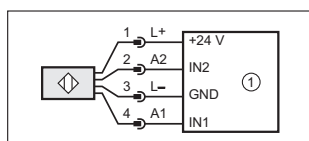

1) safety-related logic unit

Threaded sleeve, fixing nuts: Brass  
 plated with white bronze  
 Sensing face: LCP yellow  
 Connector housing: PEI

**Reliable operation without interruptions**

The sensor is equipped with sophisticated internal diagnostic functions. Among others, they detect component defects, short circuits or cross faults reliably and disconnect the outputs in case of a fault. When used as intended, maintenance of the sensor is no longer necessary.

We reserve the right to make technical alterations without prior notice. · 11.2020



Process sensors

# Front flush miniature pressure sensor with G1/4 process connection

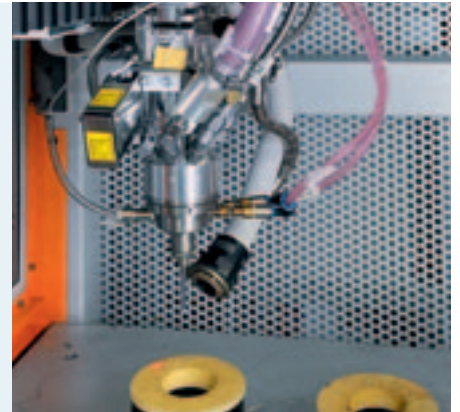

Pressure sensors



**Compact design (SW 19)**

**High measuring accuracy**  
 $< \pm 0.5 \%$

**Precise repeatability**  
 $< \pm 0.05 \%$

**Robust low-cost solution with welded stainless steel housing**

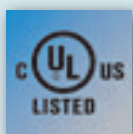
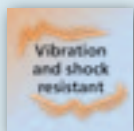

## Small and flush-mount

The new miniature pressure sensors of the PL54 series have a flush-mount diaphragm seal with G1/4 thread directly welded to the sensor. This measuring cell guarantees high accuracy in a very compact housing with only 19 mm across flats. In addition, the sensors feature a particularly cost-optimised price-performance ratio.

## Applications

The PL54 sensors are especially used for pressure measurement in applications where flush mounting is required. This is usually the case with adhesives, glues, sealants, foams and other viscous media that would cure in dead spaces. The flush connection prevents clogging of the process connection even with contaminated media.



## Accessories

| Type                         | Description                         | Order no.     |
|------------------------------|-------------------------------------|---------------|
| <b>Installation</b>          |                                     |               |
|                              | Seal FKM                            | <b>E30145</b> |
|                              | Seal EPDM                           | <b>E30442</b> |
|                              | Welding adapters G1/4               | <b>E30503</b> |
|                              | Welding aid                         | <b>E30508</b> |
| <b>Connection technology</b> |                                     |               |
|                              | M12 socket,<br>2 m black, PUR cable | <b>EVC001</b> |
|                              | M12 socket,<br>5 m black, PUR cable | <b>EVC002</b> |
|                              | M12 socket,<br>2 m black, PUR cable | <b>EVC004</b> |
|                              | M12 socket,<br>5 m black, PUR cable | <b>EVC005</b> |

## Dimensions

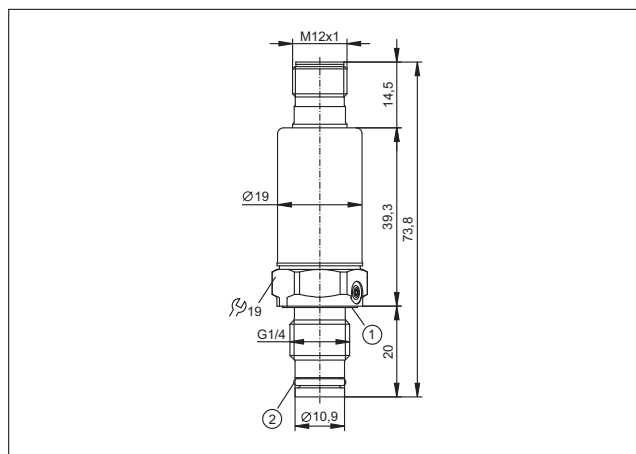

1) Seal

## Wiring

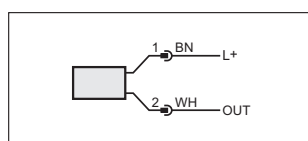

| Measuring range<br>relative pressure<br>[bar] | P <sub>overload</sub><br>max. (static)<br>[bar] | P <sub>bursting</sub><br>min.<br>[bar] | Order<br>no.  |
|---|---|--|---------------|
| <b>Output function 4...20 mA</b>              |   |  |               |
| 0...400                                       | 1000  | 1,700                                  | <b>PL5400</b> |
| 0...250                                       | 625   | 1,200                                  | <b>PL5401</b> |
| 0...160                                       | 400   | 1,100                                  | <b>PL5412</b> |
| 0...100                                       | 250   | 1000                                   | <b>PL5402</b> |
| 0...60  | 150   | 900                                    | <b>PL5423</b> |

| <b>Common technical data</b>   |        |   |
|--|--------|---|
| Operating voltage  | [V DC] | 8.5...36  |
| Reverse polarity protection  |        | •   |
| Step response time   | [ms]   | 1   |
| <b>Accuracy / deviations<br/>(in % of the span)</b>  |        |   |
| Linearity error  |        | < ± 0.5   |
| Linearity  |        | < ± 0.1 (BFSL) / < ± 0.2 (LS)                     |
| Hysteresis   |        | < ± 0.2   |
| Repeatability  |        | < ± 0.05  |
| Long-term stability  |        | < ± 0.1   |
| <b>Temperature coefficients (TEMPCO)<br/>in the temperature range -40...90°C<br/>(in % of the span per 10 K)</b> |        |   |
| TEMPCO of zero   |        | < ± 0.1 (-25...90 °C) /<br>< ± 0.2 (-40...-25 °C) |
| TEMPCO of the span   |        | < ± 0.1 (-25...90 °C) /<br>< ± 0.2 (-40...-25 °C) |
| Medium temperature   | [°C]   | -40...90  |
| Protection   |        | IP 67 / IP 69K                                    |

Materials (wetted parts) NBR, high-grade stainless steel (630 / 1.4542)

We reserve the right to make technical alterations without prior notice. · 04.2021

**ifm** – close to you!

For further technical details please visit: [ifm.com](http://ifm.com)



Process sensors

# With E1 approval: Pressure transmitters for mobile machines



Pressure sensors



**Compact design with 19 mm across flats and G 1/4-inch process connection**

**Fast response time of only 2 milliseconds**

**Measuring accuracy  $< \pm 0.8\%$ , repeatability  $< \pm 0.05\%$**

**Easy connection via M12 or DEUTSCH connector**

**Welded stainless steel housing for reliable use in harsh working environments**

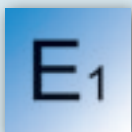
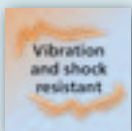

## **E1 type approval for mobile applications**

The PT/PU-type sensors are suited for mobile applications and especially for hydraulic and pneumatic applications with high operating pressure. They offer high vibration and shock resistance, a high degree of protection and very good EMC resistance. They also have the E1 type approval.

## **High measuring accuracy in compact housing**

The thin-film measuring cell of the sensor is directly welded to the process connection and features a high measuring accuracy and short response time. The measurement technology used also enables the extremely compact housing dimensions with a width across flats of only 19 millimetres. This facilitates installation even where space is at a premium.





## Accessories

| Type | Description | Order no. |
|------|-------------|-----------|
|------|-------------|-----------|

### Installation

|  |  |               |
|--|--|---------------|
|  | Adapter G 1/4 – G 1/2, high-grade stainless steel (1.4571/316Ti) | <b>E30135</b> |
|  | Seal FKM   | <b>E30145</b> |
|  | Seal EPDM  | <b>E30442</b> |

### Connection technology

|  |   |               |
|--|---|---------------|
|  | Socket, M12, 2 m, PUR cable, halogen-free, black  | <b>EVM001</b> |
|  | Socket, M12, 5 m, PUR cable, halogen-free, black  | <b>EVM002</b> |
|  | Socket, M12, 10 m, PUR cable, halogen-free, black | <b>EVM003</b> |
|  | Socket, M12, 2 m, PUR cable, halogen-free, black  | <b>EVM004</b> |
|  | Socket, M12, 5 m, PUR cable, halogen-free, black  | <b>EVM005</b> |
|  | Socket, M12, 10 m, PUR cable, halogen-free, black | <b>EVM006</b> |

## Dimensions

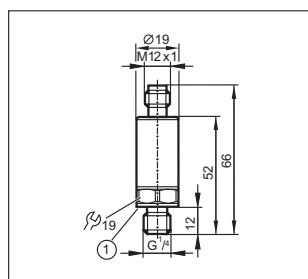

PT5 / PU5

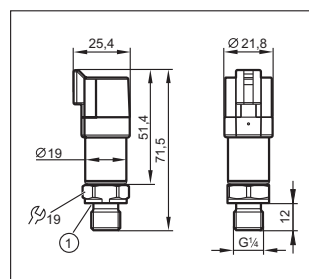

PT7  
1) Seal: FKM / DIN 3869

## Wiring diagram

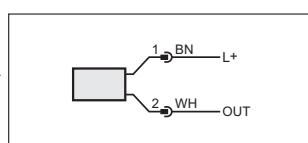

PT5

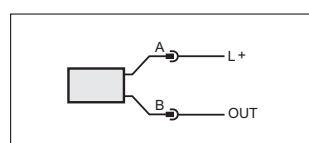

PT7

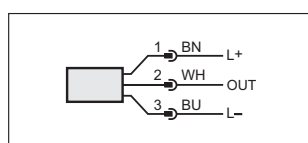

PU5

| Measuring range relative pressure [bar] | P <sub>overload</sub> max. (static) [bar] | P <sub>bursting</sub> min. [bar] | Order no. |
|---|---|----------------------------------|-----------|
|---|---|----------------------------------|-----------|

### Output function 4...20 mA, M12 connector

|         |      |      |               |
|---------|------|------|---------------|
| 0...600 | 1500 | 2500 | <b>PT560E</b> |
| 0...400 | 1000 | 1700 | <b>PT500E</b> |
| 0...250 | 625  | 1200 | <b>PT501E</b> |
| 0...100 | 250  | 1000 | <b>PT502E</b> |
| 0...25  | 65   | 600  | <b>PT503E</b> |
| 0...10  | 25   | 300  | <b>PT504E</b> |

### Output function 4...20 mA, DEUTSCH connector

|         |      |      |               |
|---------|------|------|---------------|
| 0...600 | 1500 | 2500 | <b>PT760E</b> |
| 0...400 | 1000 | 1700 | <b>PT700E</b> |
| 0...250 | 625  | 1200 | <b>PT701E</b> |
| 0...100 | 250  | 1000 | <b>PT702E</b> |
| 0...25  | 65   | 600  | <b>PT703E</b> |
| 0...10  | 25   | 300  | <b>PT704E</b> |

### Output function 0.5...4.5 V, M12 connector

|         |      |      |               |
|---------|------|------|---------------|
| 0...600 | 1500 | 2500 | <b>PU560E</b> |
| 0...400 | 1000 | 1700 | <b>PU500E</b> |
| 0...250 | 625  | 1200 | <b>PU501E</b> |
| 0...100 | 250  | 1000 | <b>PU502E</b> |
| 0...60  | 150  | 900  | <b>PU523E</b> |
| 0...25  | 65   | 600  | <b>PU503E</b> |
| 0...10  | 25   | 300  | <b>PU504E</b> |

## Common technical data

|   |        |   |
|---|--------|---|
| Operating voltage   | [V DC] | 8...32  |
| Reverse polarity protection   |        | •   |
| Accuracy / deviation (in % of the span)   |        |   |
| Linearity error   |        | < ± 0.8   |
| Linearity   |        | < ± 0.25 (BFSL) / < ± 0.5 (LS)                                  |
| Hysteresis  |        | < ± 0.2   |
| Repeatability   |        | < ± 0.05  |
| Long-term stability   |        | < ± 0.1   |
| Temperature coefficient (TEMPCO) in the temperature range -40...125°C (in % of the span per 10 K) |        |   |
| TEMPCO of zero + span   |        | < ± 0.1 (0...80 °C)<br>< ± 0.2 (-40...0 °C and 80...125 °C)     |
| Medium temperature  | [°C]   | -40...125   |
| Protection  |        | IP 67 / IP 69K  |
| Materials (wetted parts)  |        | high-grade stainless steel (1.4542) (17-4 PH / 630)             |
| Restrictor  |        | •   |
| EMC   |        | compliant with UN ECE R10 Rev. 5 ISO 11452-2: 100 V/m EN61326-1 |



Process sensors

# More than hot air: flow sensor ensures safety



Flow sensors / flow meters



**Specially developed for fresh and exhaust air monitoring on machines**

**Special adjustment to air for optimum performance**

**Robust probe for demanding applications**

**2-in-1:  
flow velocity and temperature**

**Flexible parameter setting, diagnostics and data handling thanks to IO-Link**

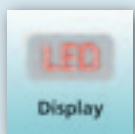

## A must for extraction systems on machines

During machining or forming processes, the use of coolants, for example, may generate toxic aerosols, smoke or vapours. Extraction systems ensure that these do not escape from the machine. What is very important is to maintain the ideal flow velocity. If the suction is too weak, the dangerous vapours would not be completely extracted. On the other hand, too strong an extraction flow could suck in chips or cooling lubricant which could clog the filter.

The flow sensor, which operates according to the calorimetric measuring principle, has been developed especially for this purpose. It is distinguished by a robust full-metal probe that is resistant to aggressive aerosols, vapours and any particles carried in the extracted air. This ensures a long service life of the sensor. The integrated temperature measurement reduces costs and installation complexity, as no additional sensor is required.



| Type   | Measuring range<br>[m/s] | Medium temperature<br>[°C] | Response time<br>[s] | Probe length<br>[mm] | Order no.     |
|--|--------------------------|----------------------------|----------------------|----------------------|---------------|
| <b>Output signal: switching signal; analogue signal; frequency signal; IO-Link; (configurable)</b> |                          |                            |                      |                      |               |
| M18  | 0.6...30                 | -20...90                   | 7                    | 45                   | <b>SA5020</b> |
| Progressive ring   | 0.6...30                 | -20...100                  | 7                    | 100                  | <b>SA4120</b> |
| Progressive ring   | 0.6...30                 | -20...100                  | 7                    | 200                  | <b>SA4320</b> |

## Accessories

| Type | Description  | Order no.     |
|------|--|---------------|
|      | USB IO-Link master for parameter setting and analysis of units<br>Supported communication protocols: IO-Link (4.8, 38.4 and 230 kbits/s) | <b>ZZ1060</b> |
|      | Progressive ring fitting G 1/2, flat seal  | <b>E40258</b> |
|      | Progressive ring fitting G 1/4, flat seal  | <b>E40259</b> |
|      | Progressive ring fitting G 3/4, flat seal  | <b>E40260</b> |
|      | Progressive ring fitting 1/2 NPT   | <b>E40261</b> |
|      | Progressive ring fitting 1/4 NPT   | <b>E40262</b> |
|      | Progressive ring fitting R 1/2   | <b>E40263</b> |
|      | Progressive ring fitting R 1/4   | <b>E40264</b> |
|      | Progressive ring fitting for SL mounting adapter   | <b>E40269</b> |
|      | Progressive ring fitting G 1/2 metal-to-metal seal   | <b>E40267</b> |
|      | Progressive ring fitting G 3/4 metal-to-metal seal   | <b>E40268</b> |
|      | Welding adapter for progressive ring   | <b>E40265</b> |
|      | Mounting clamp for E40269 progressive ring fitting   | <b>E40048</b> |
|      | Progressive ring fitting for thin-walled pipes   | <b>E43908</b> |

| Further technical data              |        |  |
|-------------------------------------|--------|--|
| Operating voltage                   | [V DC] | 18...30  |
| Precision                           |        | ± (10 % MV<br>+ 2 % VMR)   |
| Repeatability                       |        | ± (3 % MV<br>+ 0.6 % VMR)  |
| Protection rating, protection class |        | IP 65 / IP 67, III   |
| Housing materials                   |        | high-grade stainless steel (1.4404/316L);<br>PBT-GF 20;<br>PBT-GF 30 |
| Installation                        |        | adjustable to internal pipe diameter; (15...400 mm)                  |
| Connection                          |        | M12 connector  |

## Wiring diagram

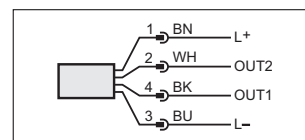

## Connection technology

| Type | Description                        | Order no.     |
|------|------------------------------------|---------------|
|      | Socket, M12, 2 m black, PUR cable  | <b>EVC001</b> |
|      | Socket, M12, 5 m black, PUR cable  | <b>EVC002</b> |
|      | Socket, M12, 2 m black, PUR cable  | <b>EVC004</b> |
|      | Socket, M12, 5 m black, PUR cable  | <b>EVC005</b> |
|      | Socket, M12, 2 m orange, PVC cable | <b>EVT064</b> |
|      | Socket, M12, 5 m orange, PVC cable | <b>EVT001</b> |



Process sensors

# Better without a float: maintenance-free capacitive level measurement





Level sensors



**Optimised for use in hydraulic oils and coolants**

**No maintenance necessary, free from mechanical parts**

**Easy adjustment and setting of the output function via inductive teach button**

-  **2 configurable switching outputs defined by media or temperature**
-  **Adjustment to different media (e.g. water/oil)**

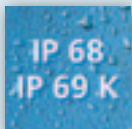

## Reliable alternative for float switches

The LI level sensor is perfectly suited for the detection of level or leakage. The capacitive measurement technology has no moving parts, which eliminates mechanical failures due to deposits. This increases machine availability, saving maintenance costs and time.

## Plug and play point level sensor with digital communication

The LI comes pre-programmed from the factory for use in water-based applications making installation plug and play. No additional setup is required for simple point level applications.

Additionally, the sensor outputs can be programmed via an inductive teach button or IO-Link digital communication can be used to get both point level and temperature over a single wire.



## Accessories



| Design | Description | Order no. |
|--------|-------------|-----------|
|--------|-------------|-----------|

### Mounting accessories

|   |  |               |
|---|--|---------------|
|  | Mounting clamp for level sensors Ø 16 mm | <b>E43000</b> |
|---|--|---------------|

|   |  |               |
|---|--|---------------|
|  | Mounting clamp for level sensors Ø 16 mm | <b>E43016</b> |
|---|--|---------------|

### Mounting adapters

|   |  |               |
|---|--|---------------|
|  | Mounting adapter, G 3/4, stainless steel                     | <b>E43003</b> |
|  | Installation adapter for level sensors, D16, stainless steel | <b>E43004</b> |

|   |  |               |
|---|--|---------------|
|  | Flange plate for level sensors, 65-80 mm, anodised aluminium | <b>E43006</b> |
|---|--|---------------|

|   |  |               |
|---|--|---------------|
|  | Flange plate for level sensors, 73-90 mm, anodised aluminium | <b>E43001</b> |
|---|--|---------------|

|  |  |               |
|--|--|---------------|
|  | Flange plate for level sensors, 100-125 mm, anodised aluminium | <b>E43005</b> |
|--|--|---------------|

|   |  |               |
|---|--|---------------|
|  | Mounting adapter for level sensors, D16; nickel-plated brass | <b>E43019</b> |
|---|--|---------------|

|   |   |               |
|---|---|---------------|
|  | Flange plate for level sensors, 54-52 x 52 mm, anodised aluminium | <b>E43007</b> |
|---|---|---------------|

|  |   |               |
|--|---|---------------|
|  | Mounting adapter for level sensors; 3/4" NPT, stainless steel | <b>E43012</b> |
|--|---|---------------|

|  |   |               |
|--|---|---------------|
|  | Mounting adapter for level sensors; 1" NPT, stainless steel | <b>E43013</b> |
|--|---|---------------|

### Welding adapter

|   |  |               |
|---|--|---------------|
|  | Welding adapter for level sensors Ø 50 mm, stainless steel | <b>E43002</b> |
|---|--|---------------|

### IO-Link accessories

|   |   |               |
|---|---|---------------|
|  | USB IO-Link master for parameter setting and analysis of units<br>Supported communication protocols:<br>IO-Link (4.8, 38.4 and 230 Kbits/s) | <b>ZZ1060</b> |
|---|---|---------------|

|   |   |               |
|---|---|---------------|
|  | LR DEVICE (supplied on USB flash drive)<br>Software for online and offline parameter setting of IO-Link sensors and actuators | <b>QA0011</b> |
|---|---|---------------|

| Probe length [mm] | Temperature water [°C] | Temperature oil [°C] | Order no. |
|-------------------|------------------------|----------------------|-----------|
|-------------------|------------------------|----------------------|-----------|

2 switching outputs, 1 x temperature, 1 x level or 2 x level depending on the damping (e.g. water/oil)

|     |          |          |               |
|-----|----------|----------|---------------|
| 132 | -25...85 | -25...85 | <b>LI5131</b> |
| 273 | -25...85 | -25...85 | <b>LI5132</b> |
| 481 | -25...85 | -25...85 | <b>LI5133</b> |
| 737 | -25...85 | -25...85 | <b>LI5134</b> |

### Further technical data

|                                     |        |                                 |
|-------------------------------------|--------|---------------------------------|
| Operating voltage                   | [V DC] | 9,6...35;<br>(IO-Link: 18...30) |
| Ambient temperature                 | [°C]   | -25...80                        |
| Process connection                  | [mm]   | Ø 16                            |
| Protection rating, protection class |        | IP 68; IP 69K, III              |
| Tank pressure                       | [bar]  | 0,5                             |

### Dimensions

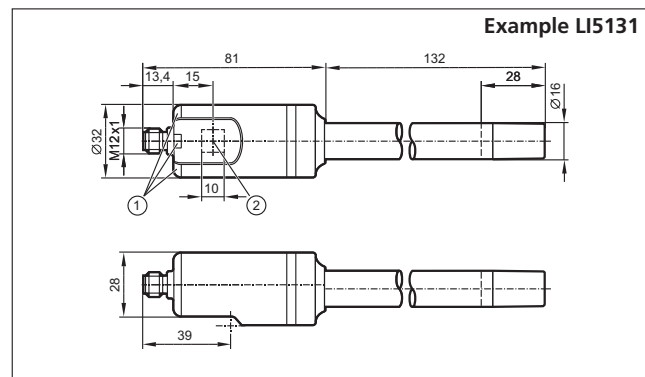

- 1) LED
- 2) inductive teach button

### Wiring diagram

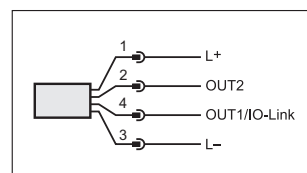



Process sensors

# Air humidity sensor: ensure the perfect climate for your processes

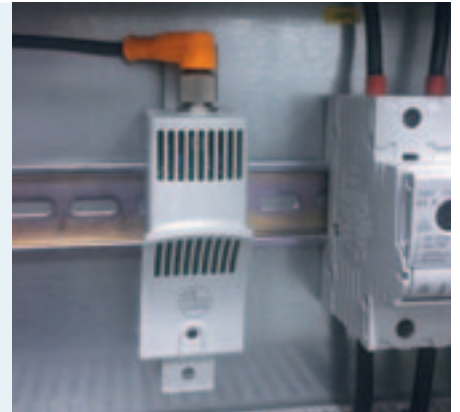

Analytical sensors



Easy temperature and air humidity monitoring for protection of electrical systems, control cabinets or production processes

Plug & play thanks to screw or DIN rail mounting and M12 connector

Data output via analogue signal or IO-Link

↻ Easy sensor replacement – parameters are set automatically when connected to an IO-Link master



## Permanent temperature and humidity control

The air humidity sensor provides transparency and safety for electrical installations and sensitive production processes. Fixtures for wall or DIN rail mounting and a standard M12 connector guarantee quick and error-free installation. Depending on the type, the sensor transmits the temperature and relative humidity to the controller via IO-Link in analogue or digital form.

This makes it possible to protect control cabinets or test benches as well as electrical installations exposed to weather and moist conditions, such as drinks vending machines, radar measuring points or ticket machines, from moisture-related malfunctions or short circuits. In addition, the air humidity sensor can be used for quality assurance of temperature or moisture-sensitive production processes, enabling permanent indoor climate monitoring.





## Accessories

| Type | Description | Order no. |
|------|-------------|-----------|
|------|-------------|-----------|

### IO-Link

|  |  |               |
|--|--|---------------|
|  | USB IO-Link master for parameter setting and analysis of units<br>Supported communication protocols: IO-Link (4.8, 38.4 and 230 kbits/s) | <b>ZZ1060</b> |
|--|--|---------------|

|  |   |               |
|--|---|---------------|
|  | LR DEVICE (supplied on USB flash drive)<br>Software for online and offline parameter setting of IO-Link sensors and actuators | <b>QA0011</b> |
|--|---|---------------|

### Connection technology

|  |   |               |
|--|---|---------------|
|  | Socket, M12, 4 poles<br>5 m, grey, MPPE cable | <b>EVF001</b> |
|  | Socket, M12, 4 poles<br>2 m, grey, MPPE cable | <b>EVF064</b> |

|  |   |               |
|--|---|---------------|
|  | Socket, M12, 4 poles<br>5 m, grey, MPPE cable | <b>EVF004</b> |
|  | Socket, M12, 4 poles<br>2 m, grey, MPPE cable | <b>EVF067</b> |

|  |                                       |               |
|--|---------------------------------------|---------------|
|  | Socket, M12,<br>2 m, black, PUR cable | <b>EVC001</b> |
|  | Socket, M12,<br>5 m, black, PUR cable | <b>EVC002</b> |

|  |                                       |               |
|--|---------------------------------------|---------------|
|  | Socket, M12,<br>2 m, black, PUR cable | <b>EVC004</b> |
|  | Socket, M12,<br>5 m, black, PUR cable | <b>EVC005</b> |

## Wiring diagram

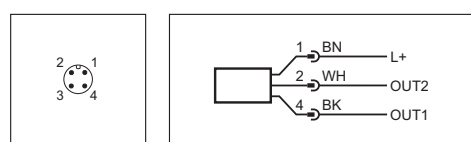

### LDH290

OUT1: 4...20 mA (temperature)  
OUT2: 4...20 mA (relative humidity)

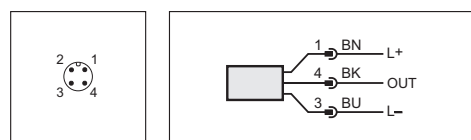

### LDH292

OUT: IO-Link

## Technical data

| Description<br>2 x 4...20 mA | Order no.<br>LDH290 |
|------------------------------|---------------------|
|------------------------------|---------------------|

|                               |        |          |
|-------------------------------|--------|----------|
| Operating voltage             | [V DC] | 12...30  |
| Temperature measuring range   | [°C]   | -40...60 |
| Temperature application range | [°C]   | -40...70 |
| Max. power consumption        | [W]    | 1.8      |

| Description<br>IO-Link | Order no.<br>LDH292 |
|------------------------|---------------------|
|------------------------|---------------------|

|                               |        |          |
|-------------------------------|--------|----------|
| Operating voltage             | [V DC] | 18...30  |
| Temperature measuring range   | [°C]   | -40...80 |
| Temperature application range | [°C]   | -40...80 |
| Max. power consumption        | [W]    | 0.3      |

### Common technical data

|                                     |                    |
|-------------------------------------|--------------------|
| Protection rating, protection class | IP 20, III         |
| Fastening - DIN rail                | 35 mm DIN rail     |
| Fastening - screws                  | M5                 |
| Connection                          | M12 connector      |
| Dimensions (H x W x D)              | [mm] 140 x 40 x 38 |

## Dimensions

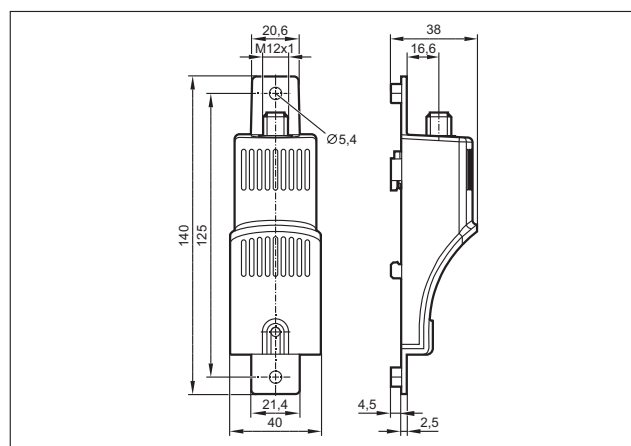



Process sensors



# Conductivity sensor for clamp and hygienic pipe fittings

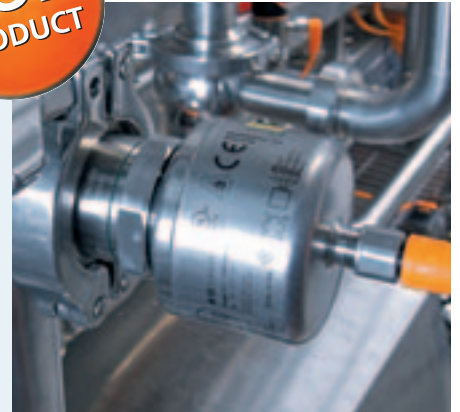

Analytical sensors



**Solid tip prevents breakage**

**Reduce inaccuracies associated with a time-based cleaning process**

**Flexible process adjustments increase system efficiency**

↙ **Easily adapted to new recipes and media**

↙ **Loss-free digital transmission of measured values**

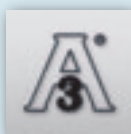
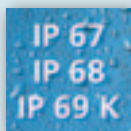
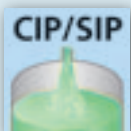

### Applications

The sensors are used in cleaning processes (CIP) in the food industry. They detect the concentration of cleaning agents, check the rinsing water for residues and are used for product validation.

### Potential

Precise, fast and reliable measurements during the process help to improve plant availability and optimise cleaning cycles. A reduced amount of cleaning agents, lower energy consumption during rinsing and lower water consumption result in considerable cost savings. In addition, the machine uptime is increased.

### Stability

The solid tip design guarantees stability even if the sensor is exposed to increased stress.



## Accessories

| Type  | Description   | Order no.     |
|---|---|---------------|
| <b>Welding adapter</b>  |   |               |
|                                | D60 – G 1 external thread Aseptoflex Vario with leakage port              | <b>E30149</b> |
|   | D60 – G 1 external thread Aseptoflex Vario                                | <b>E30150</b> |
|                                | D50 – G 1 external thread Aseptoflex Vario                                | <b>E30122</b> |
|   | D50 – G 1 external thread Aseptoflex Vario with leakage port              | <b>E30130</b> |
|   | D38 – G 1 external thread Aseptoflex Vario with leakage port              | <b>E30500</b> |
|                                | G 1 welding mandrel   | <b>E30435</b> |
| <b>Process adapters clamp and hygienic pipe fittings</b>  |   |               |
|                               | Clamp – G 1 Aseptoflex Vario DN50 with leakage port                       | <b>E33309</b> |
|  | Tri-clamp – G 1 Aseptoflex Vario 2" with leakage port                     | <b>E33209</b> |
|   | Tri-clamp – G 1 Aseptoflex Vario 2"                                       | <b>E33202</b> |
|   | Tri-clamp – G 1 Aseptoflex Vario 1.5" with leakage port                   | <b>E33208</b> |
|   | Tri-clamp – G 1 Aseptoflex Vario 1 – 1.5" with leakage port               | <b>E33201</b> |
|                              | Hygienic pipe fitting – G 1 Aseptoflex Vario 1.5"                         | <b>E33212</b> |
|   | Hygienic pipe fitting – G 1 Aseptoflex Vario 2"                           | <b>E33213</b> |
|   | Hygienic pipe fitting – G 1 Aseptoflex Vario 1.25"                        | <b>E33211</b> |
|                              | Pipe fitting – G 1 Aseptoflex Vario DN33,7 Series B with leakage port     | <b>E33304</b> |
|                              | Pipe fitting – G 1 Aseptoflex Vario DN40 with leakage port                | <b>E33302</b> |
|                              | Clamp connection with notch – G 1 Aseptoflex Vario DN40 with leakage port | <b>E33308</b> |

| Process connection | Installation depth [mm] | Order no. |
|--------------------|-------------------------|-----------|
|--------------------|-------------------------|-----------|

**Application: version with long tip, installation in screwed socket connections**

|                      |    |               |
|----------------------|----|---------------|
| G 1 Aseptoflex Vario | 77 | <b>LDL201</b> |
|----------------------|----|---------------|



### Further technical data

|                                    |         |   |
|------------------------------------|---------|---|
| Operating voltage                  | [V DC]  | 18...30   |
| Current consumption                | [mA]    | < 70  |
| Measuring range conductivity       | [µS/cm] | 100...1000000                                   |
| Measuring range medium temperature | [°C]    | -25...100;<br>(< 1 h: 150)                      |
| Pressure rating                    | [bar]   | 16  |
| Conductivity accuracy              |         | 2 % MW ± 25 µS/cm                               |
| Conductivity repeatability         |         | 1 % MW ± 25 µS/cm                               |
| Materials                          |         | Stainless steel (1.4404 / 316L); PEEK; PEI; FKM |



## Accessories

| Type | Description | Order no. |
|------|-------------|-----------|
|------|-------------|-----------|

### IO-Link

|   |  |               |
|---|--|---------------|
|  | USB IO-Link master for parameter setting and analysis of units<br>Supported communication protocols: IO-Link (4.8, 38.4 and 230 kbits/s) | <b>ZZ1060</b> |
|  | LR DEVICE (supplied on USB flash drive)<br>Software for online and offline parameter setting of IO-Link sensors and actuators            | <b>QA0011</b> |

### Connection technology

|   |   |               |
|---|---|---------------|
|  | Socket, M12, 4 poles<br>5 m, grey, MPPE cable | <b>EVF001</b> |
|   | Socket, M12, 4 poles<br>2 m, grey, MPPE cable | <b>EVF064</b> |
|  | Socket, M12, 4 poles<br>5 m, grey, MPPE cable | <b>EVF004</b> |
|   | Socket, M12, 4 poles<br>2 m, grey, MPPE cable | <b>EVF067</b> |

### Advantages of LDL at a glance:

#### Much shorter commissioning time

- No need for additional evaluation electronics
- Simple wiring using M12 connector

#### Robust and compact design

- The fully welded stainless steel housing prevents water ingress
- Tip made of solid material prevents breakage under high load

#### Attractive offer

- High availability and fast delivery times
- Flexible adapter concept reduces / simplifies warehousing



# For AS-i and IO-Link: passive power distributor for hygienic areas



AS-i interface I/O modules,  
field modules for wet areas



**Robust field module supplies up to 8 IO-Link masters or AS-i participants**

**Housing material meets the hygiene requirements for food production**

**Voltage supply via standard M12 supply cables, A-coded**

**Overcurrent detection for each port**

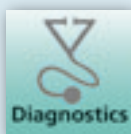
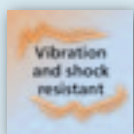

### Two options

The passive power distributor can be operated either in AS-i networks or in IO-Link structures. This helps to minimise stock-holding, especially where both technologies are used. Up to 8 participants, either intelligent AS-i sensors or actuators or IO-Link masters, can be connected via standard M12 sockets.

### Robust design for demanding applications

The special housing material and the high ingress protection allow operation in areas with frequent intensive cleaning processes, for example in the food industry. The module signals an excessive current flow per port via a red LED. Malfunctions or damage to infrastructure, actuators or even the plant can thus be avoided.



## Advantages and customer benefits

### • AS-i or IO-Link power distributor

These power distributors can be used in hygienic applications due to the materials used and their innovative housing design.

The 4-way or 8-way power distributors can either be used to supply up to 8 AS-i participants, e.g. valve heads, quarter-turn sensors, motor controls etc., or to supply power to IO-Link masters.

Overcurrent detection indicates by a red-flashing LED at the respective M12 connection that more than the permitted 4.4 A per channel are being drawn.

## Technical data

### AS-i or IO-Link power distributor

#### AC2950 (4-way), AC2951 (8-way)



#### AS-i operation

|                           |        |                   |
|---------------------------|--------|-------------------|
| Operating voltage         | [V DC] | 18...31.6; (AS-i) |
| Additional voltage supply | [V DC] | 15...30; (AUX)    |

#### IO-Link operation

|                           |        |                                      |
|---------------------------|--------|--------------------------------------|
| Operating voltage         | [V DC] | 20 ... 30 US                         |
| Additional voltage supply | [V DC] | 20 ... 30 UA                         |
| Total current rating      | [A]    | 8; (AS-i 4; AUX: 4; US:4; UA:4)      |
| Overcurrent detection     |        | yes (per channel)                    |
| Ambient temperature       | [°C]   | -25...60                             |
| Storage temperature       | [°C]   | -25...85                             |
| Protection rating         |        | IP 65, IP 66, IP 67, IP 69K          |
| Housing materials         |        | polyamide;<br>socket stainless steel |
| M12 plugs / sockets       |        | A-coded                              |

## Accessories

| Design  | Description  | Order no. |
|---|--|-----------|
|  | M12 protective caps, 4 pcs, high-grade stainless steel                             | E12542    |
|  | AS-Interface FC insulation displacement connector, stainless steel (1.4404 / 316L) | E70354    |

## Connection technology

| Design  | Description | Order no. |
|---|-------------|-----------|
| <b>M12 1mm<sup>2</sup></b>  |             |           |
|  | 0.25 m      | EVF490    |
|   | 0.5 m       | EVF491    |
|   | 1 m         | EVF492    |
|   | 2 m         | EVF493    |
|   | 5 m         | EVF494    |

## Dimensions

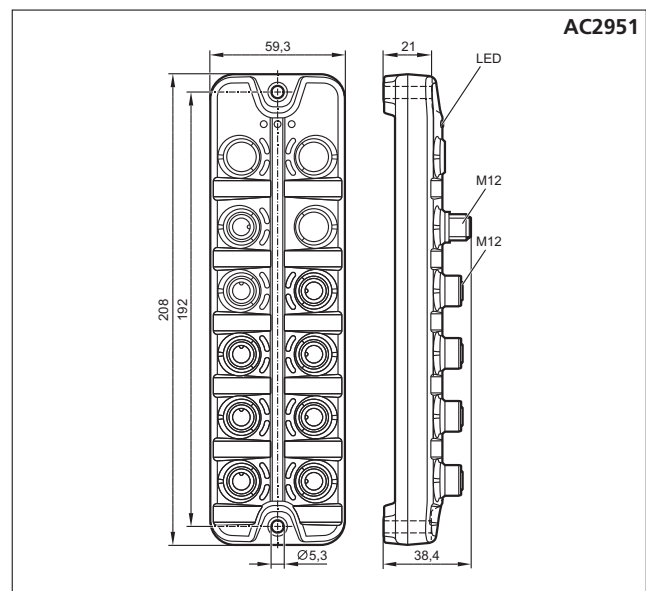
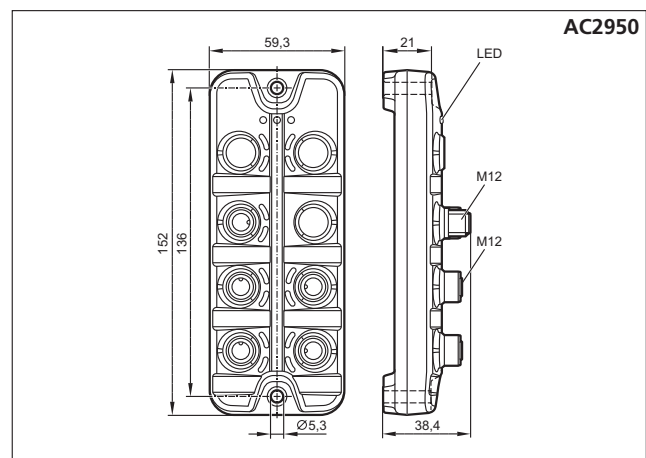



# Robust data distribution: Ethernet switches for field applications



Industrial Ethernet switches (unmanaged)



**6-port Ethernet switch compatible with all common automation protocols and IIoT applications**

**Flexible voltage supply with or without daisy chain**

**Suited for mobile machines thanks to increased operating voltage and temperature range**

**Robust housings, food-grade option available**

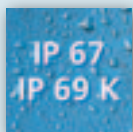

## Ethernet switches for field applications

The decentralised modules serve as network nodes between the participants in the field. They are connected directly via robust and reliable M12 connection cables. The use of EVC connection cables with ecolink technology ensures a particularly robust connection and thus reliable data transfer. The M12 connector ensures a much more secure connection than an RJ-45 connector - especially outside the control cabinet.



## Robust proven materials

The Ethernet modules are the perfect choice, even in the most difficult environments: The materials and production methods are identical to the EVC jumper cables.





## Products

| Design  | Description  | Order no.     |               |
|---|--|---------------|---------------|
|   |  | Coolant       | Food          |
| <b>Ethernet 6-port switches (unmanaged)</b>                                       |  |               |               |
|  | StandardLine IIoT (TCP/IP), EtherNet/IP, Modbus TCP    | <b>AL3050</b> | <b>AL3051</b> |
|   | StandardLine PROFINET CC-A                             | <b>AL3000</b> | <b>AL3001</b> |
|  | PerformanceLine IIoT (TCP/IP), EtherNet/IP, Modbus TCP | <b>AL3150</b> | <b>AL3151</b> |
|   | PerformanceLine PROFINET CC-A                          | <b>AL3100</b> | <b>AL3101</b> |

## Advantages and customer benefits

### • Expansion of the IO-Link master family

The Ethernet switches are the perfect addition to ifm's IO-Link master family. They feature the same design, port configuration and standardised M12 connections.

### • Also suited for mobile machines

With their increased operating temperature and voltage range as well as high vibration and shock resistance, the switches are also suited for harsh environments. In addition, the E20 approval means that the product is also suited for use outside vehicles.

### • Simple voltage supply

The Ethernet modules offer different connection options for the voltage supply: an A-coded M12 connector and an L-coded M12 connector. The latter can be daisy-chained to other modules of the product family.

## Connection technology

| Design  | Description               | Order no.         |               |
|---|---------------------------|-------------------|---------------|
|   |                           | Coolant           | Food          |
| <b>Ethernet cable</b>   |                           | <b>RJ45 - M12</b> |               |
|    | 0.5 m                     | <b>EVC924</b>     | <b>EVF549</b> |
|   | 2 m                       | <b>EVC926</b>     | <b>EVF551</b> |
|   | 5 m                       | <b>EVC927</b>     | <b>EVF552</b> |
|   | 10 m                      | <b>EVC928</b>     | <b>EVF553</b> |
| <b>Ethernet cable</b>   |                           | <b>M12 - M12</b>  |               |
|    | 0.5 m                     | <b>EVC904</b>     | <b>EVF429</b> |
|   | 2 m                       | <b>EVC906</b>     | <b>EVF531</b> |
|   | 5 m                       | <b>EVC907</b>     | <b>EVF532</b> |
|   | 10 m                      | <b>EVC908</b>     | <b>EVF533</b> |
|   | 20 m                      | <b>EVC909</b>     | <b>EVF534</b> |
| <b>Socket, A-coded (power)</b>  |                           | <b>M12 - open</b> |               |
|    | 2 m; 1 mm <sup>2</sup>    | <b>EVC706</b>     | <b>EVF480</b> |
|   | 5 m; 1 mm <sup>2</sup>    | <b>EVC707</b>     | <b>EVF481</b> |
|   | 10 m; 1 mm <sup>2</sup>   | <b>EVC708</b>     | <b>EVF482</b> |
|   |                           | -                 | -             |
| <b>Socket, L-coded (power)</b>  |                           | <b>M12 - open</b> |               |
|  | 2 m; 2.5 mm <sup>2</sup>  | <b>E12641</b>     | -             |
|   | 5 m; 2.5 mm <sup>2</sup>  | <b>E12642</b>     | -             |
|   | 10 m; 2.5 mm <sup>2</sup> | <b>E12643</b>     | -             |
|   | -                         | -                 |               |
| <b>Connection cable, L-coded (power)</b>  |                           | <b>M12 - M12</b>  |               |
|  | 2 m; 2.5 mm <sup>2</sup>  | <b>E12654</b>     | -             |
|   | 5 m; 2.5 mm <sup>2</sup>  | <b>E12655</b>     | -             |
|   | 10 m; 2.5 mm <sup>2</sup> | <b>E12656</b>     | -             |
|   |                           | -                 | -             |

## Further technical data

| Unmanaged Ethernet switches | AL3050 IIoT / AL3000 PROFINET CC-A          | AL3051 IIoT / AL3001 PROFINET CC-A | AL3150 IIoT / AL3100 PROFINET CC-A     | AL3151 IIoT / AL3101 PROFINET CC-A |
|-----------------------------|---|------------------------------------|--|------------------------------------|
|                             | StandardLine                                |                                    | PerformanceLine                        |                                    |
| Operating voltage [V DC]    | 8...32 (US; to SELV / PELV)                 |                                    |  |                                    |
| Current consumption [mA]    | 100 (US)                                    |                                    |  |                                    |
| Interface                   | Ethernet                                    |                                    |  |                                    |
| Number of ports             | 6   |                                    |  |                                    |
| Transmission standard       | 10Base-T (IEEE 802.3i); 100Base-TX (802.3u) |                                    |  |                                    |
| Transmission rate [Mbits/s] | 10; 100                                     |                                    |  |                                    |
| Ambient temperature [°C]    | -25...70                                    |                                    |  |                                    |
| Daisy chain voltage supply  | no  |                                    | yes                                    |                                    |
| Voltage supply connection   | M12 A-coded                                 |                                    | M12 L-coded                            |                                    |
| Protection rating           | IP 65, IP 66, IP 67                         | IP 65, IP 66, IP 67, IP 69K        | IP 65, IP 66, IP 67                    | IP 65, IP 66, IP 67, IP 69K        |
| Housing material            | polyamide; socket: nickel-plated brass      | polyamide; socket: stainless steel | polyamide; socket: nickel-plated brass | polyamide; socket: stainless steel |

We reserve the right to make technical alterations without prior notice. · 04.2021



IO-Link

# IO-Link master: Connection of sensors to the PLC and to the IT world



IO-Link master  
DataLine Coolant / Food



**Industry 4.0 ready via new IoT core**

**Separation between automation and IT network**

**4 or 8 IO-Link ports with full V1.1 functionality**

**PROFINET, EtherNet/IP, EtherCat, Modbus TCP, TCP/IP JSON or Powerlink**

**Master and device configurable via the LR DEVICE software**



## IO-Link master for the automation and IT world

The decentralised IO-Link master modules serve as a gateway between intelligent IO-Link sensors and the field bus. Besides, important information of the intelligent sensors can simultaneously be sent into the IT world. With a separate IoT Ethernet socket the IT network can be set up completely separated from the automation network. Sensor information is transferred into the IT world via the established TCP/IP JSON interface.

## Robust field bus modules for demanding applications

Thanks to their special housing materials and high ingress resistance (IP 67 or IP 69K), they can be used in coolant applications or directly in wet areas in the food industry. The ecolink technology guarantees reliable, permanently ingress-resistant M12 connections of the connection cables.



## Advantages and customer benefits

### • Separation between automation and IT network

Machine uptime is of highest priority. The automation network must by no means be interrupted by external factors. Therefore the unit features a separate IoT Ethernet socket separating IT and automation network. This means that important sensor information can be safely sent to the IT and ERP system.

### • Sensor configuration with LR DEVICE

The intuitive software finds all IO-Link masters in the network and creates an overview of the whole plant. In addition, all connected sensors are displayed with the respective parameters. This makes it possible to set the parameters of all sensors in the system from one central point.

### • Easy sensor connection

The sensors and actuators are connected via standard M12 connection cables without screening. Depending on the device type, up to 4 or 8 IO-Link sensors can be connected and supplied with up to 3.6 A. With the EVC693 or EVF693 accessories, additional auxiliary power for the connection of IO-Link actuators can be supplied. The cable can be up to 20 m long.

## Connection technology

| Type   | Description | Order no. |        |
|--|-------------|-----------|--------|
|  |             | Coolant   | Food   |
| <b>Ethernet cable (fieldbus)</b>                     |             |           |        |
|  | 0.5 m       | E12490    | EVF530 |
|  | 2 m         | E12090    | EVF531 |
|  | 5 m         | E12491    | EVF532 |
|  | 10 m        | E12492    | EVF533 |
| <b>M12 socket 1 mm<sup>2</sup> (power)</b>           |             |           |        |
|  | 2 m         | EVC706    | EVF480 |
|  | 5 m         | EVC707    | EVF481 |
|  | 10 m        | EVC708    | EVF482 |
|  | 20 m        | EVC709    | EVF483 |
| <b>M12 jumper cable 0.34 mm<sup>2</sup> (sensor)</b> |             |           |        |
|  | 1 m         | EVC042    | EVF042 |
|  | 2 m         | EVC043    | EVF043 |
|  | 5 m         | EVC044    | EVF044 |
|  | 10 m        | EVC493    | EVF045 |
| <b>Y splitter (adapter A port / B port)</b>          |             |           |        |
|  | 1 m         | EVC693    | EVF693 |
|  | 2 m         | EVC694    | EVF694 |
|  | 5 m         | EVC695    | EVF695 |
|  | 10 m        | EVC696    | EVF696 |

## The products

| Type                           | Description              | Order no. |        |
|--------------------------------|--------------------------|-----------|--------|
|                                |                          | Coolant   | Food   |
| <b>IO-Link master DataLine</b> |                          |           |        |
|                                | PROFINET + IoT 4 Port    | AL1300    | AL1301 |
|                                | EtherNet/IP + IoT 4 Port | AL1320    | AL1321 |
|                                | EtherCat + IoT 4 Port    | AL1330    | AL1331 |
|                                | Modbus TCP + IoT 4 Port  | AL1340    | AL1341 |
|                                | IoT only 4 Port          | AL1350    | AL1351 |
|                                | Powerlink + IoT 4 Port   | AL1370    | AL1371 |
|                                | PROFINET + IoT 8 Port    | AL1302    | AL1303 |
|                                | EtherNet/IP + IoT 8 Port | AL1322    | AL1323 |
|                                | EtherCat + IoT 8 Port    | AL1332    | AL1333 |
|                                | Modbus TCP + IoT 8 Port  | AL1342    | AL1343 |
|                                | IoT only 8 Port          | AL1352    | AL1353 |
|                                | Powerlink + IoT 8 Port   | AL1372    | AL1373 |

## Technical data

| IO-Link master DataLine Coolant / Food | Order no.  |  |  |  |
|--|--|--|--|--|
|  | AL1300<br>AL1320<br>AL1330<br>AL1340<br>AL1350<br>AL1370 | AL1302<br>AL1322<br>AL1332<br>AL1342<br>AL1352<br>AL1372 | AL1301<br>AL1321<br>AL1331<br>AL1341<br>AL1351<br>AL1371 | AL1303<br>AL1323<br>AL1333<br>AL1343<br>AL1353<br>AL1373 |
| Operating voltage                      | 20...30 V DC   |  |  |  |
| Total current consumption              | ≤ 3.9 A  |  |  |  |
| IO-Link version                        | 1.1  |  |  |  |
| Number of IO-Link ports                | 4 A ports  | 8 A ports  | 4 A ports  | 8 A ports  |
| Number of binary inputs                | 4 + 4  | 8 + 8  | 4 + 4  | 8 + 8  |
| Number of binary outputs               | 4  | 8  | 4  | 8  |
| Parameter memory                       | •  |  |  |  |
| Current for all A ports                | ≤ 3.6 A (device supply)                                  |  |  |  |
| Protection                             | IP 65, IP 67   |  | IP 65, IP 67, IP 69K                                     |  |
| Ambient temperature                    | -25...60 °C  |  |  |  |
| Housing materials / socket             | Polyamide / brass nickel-plated                          |  | Polyamide / stainless steel                              |  |

## Accessories

| Type | Description  | Order no. |
|------|--|-----------|
|      | LR DEVICE (supplied on USB flash drive) Software for online and offline parameter setting of IO-Link sensors and actuators | QA0011    |
|      | Coolant, protective caps M12, (10 pcs)   | E73004    |

We reserve the right to make technical alterations without prior notice. · 04.2021

**ifm** – close to you!

For further technical details please visit: [ifm.com](http://ifm.com)



IO-Link

# IO-Link master for intelligent sensors in the control cabinet



IO-Link masters CabinetLine



Separation between automation and IT network

Industry 4.0 ready via new IoT core

8 IO-Link ports with full V1.1 functionality

PROFINET, Ethernet/IP, EtherCat, Modbus TCP, TCP/IP JSON or Powerlink

Master and device configurable via the LR DEVICE software

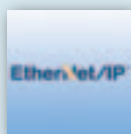

## IO-Link master for the automation and IT world

The IO-Link master modules for the control cabinet serve as a gateway between intelligent IO-Link sensors and the field bus. Besides, important information of the intelligent sensors can simultaneously be sent into the IT world.

With a separate IoT Ethernet socket the IT network can be set up completely separated from the automation network. Sensor information is transferred into the IT world via the established TCP/IP JSON interface.



## Advantages and customer benefits

### • Separation between automation and IT network

Machine uptime is of highest priority. The automation network must by no means be interrupted by external factors. Therefore the unit features a separate IoT Ethernet socket separating IT and automation network. This means that important sensor information can be safely sent to the IT and ERP systems.

### • Sensor configuration with LR DEVICE

The intuitive software finds all IO-Link masters in the network and creates an overview of the whole plant. In addition, all connected sensors are displayed with the respective parameters. This makes it possible to set the parameters of all sensors in the system from one central point.

### • Easy sensor connection

The sensors and actuators are connected via standard M12 connection cables without screening. The connection cables are fixed via removable COMBICON connectors on the IO-Link master. Up to 8 IO-Link sensors can be connected and be supplied with up to 3.6 A. The cable can be up to 20 m long.

### • Reliable digital data

The sensor data is transferred digitally. Unlike analogue signals, contact resistance and EMC interference cannot corrupt the signals.

## Dimensions

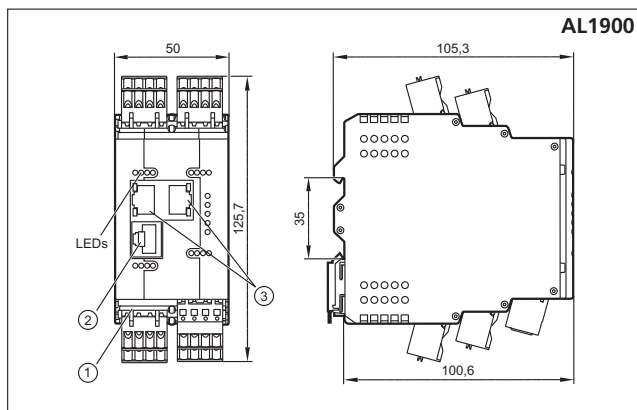

- 1) Combicon connector
- 2) IoT-Port
- 3) Profinet IO data interface

## The products

| Type                              | Description              | Order no.     |
|-----------------------------------|--------------------------|---------------|
| <b>IO-Link master CabinetLine</b> |                          |               |
|                                   | PROFINET + IoT 8-port    | <b>AL1900</b> |
|                                   | EtherNet/IP + IoT 8-port | <b>AL1920</b> |
|                                   | EtherCat + IoT 8-port    | <b>AL1930</b> |
|                                   | Modbus TCP + IoT 8-port  | <b>AL1940</b> |
|                                   | Powerlink + IoT 8 Port   | <b>AL1970</b> |
|                                   | IoT only 8-port          | <b>AL1950</b> |

## Technical data

| IO-Link master CabinetLine<br>AL1900, AL1920, AL1930, AL1940, AL1970 |        |                    |
|--|--------|--------------------|
| Operating voltage  | [V DC] | 20...30            |
| Total current consumption  | [A]    | ≤ 3.9              |
| IO-Link version  |        | 1.1                |
| Number of IO-Link ports  |        | 8 A ports          |
| Number of binary inputs  |        | 8 + 8              |
| Number of binary outputs   |        | 8                  |
| Parameter memory   |        | •                  |
| Current for all ports (device supply)                                | [A]    | ≤ 3.6              |
| Protection   |        | IP 20              |
| Electrical connections   |        | COMBICON connector |
| Installation   |        | DIN rail           |
| Ambient temperature  | [°C]   | -25...65           |
| Dimensions   | [mm]   | 114.2 x 50 x 105.3 |

## Accessories

| Type | Description   | Order no.     |
|------|---|---------------|
|      | LR DEVICE (supplied on USB flash drive)<br>Software for online and offline parameter setting of IO-Link sensors and actuators | <b>QA0011</b> |
|      | Ethernet adapter M12 / RJ45   | <b>E21140</b> |

## Connection technology

| Type              | Description           | Order no.     |
|-------------------|-----------------------|---------------|
| <b>M12 socket</b> |                       |               |
|                   | 1 m black, PUR cable  | <b>EVC471</b> |
|                   | 2 m black, PUR cable  | <b>EVC001</b> |
|                   | 5 m black, PUR cable  | <b>EVC002</b> |
|                   | 10 m black, PUR cable | <b>EVC003</b> |
|                   | 20 m black, PUR cable | <b>EVC083</b> |

For further technical details please visit: [ifm.com](http://ifm.com)





IO-Link

# Connect IO-Link to a PC via USB



USB IO-Link master



**For connecting IO-Link sensors to a PC via USB**

**For quick parameter setting and easy reading of IO-Link sensors**

**Does not require a separate power supply**

**Industrially compatible, robust M12 connectors**

**Complete set with sensor cable, USB cable and parameter setting software**

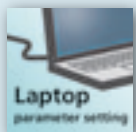

## IO-Link for the PC

The AL1060 interface is a 1-port IO-Link master that acts as a gateway, establishing a connection between the IO-Link communication and a PC (via USB interface).

This allows users to conveniently configure sensors with IO-Link capability on a PC with the corresponding software prior to installation in the plant. This considerably reduces the set-up time and minimises setting faults.

For most sensors, no separate power supply is required. This makes it particularly easy to connect sensors installed in the plant to a laptop, e.g. to read out process values or adjust sensor parameters on site.





## Advantages and customer benefits

- **No power supply required**

The AL1060 interface has a powerful integrated voltage converter, which generates a 24 V sensor voltage from the 5 V USB voltage at the IO-Link port. Depending on the computer, this output can be loaded with up to 150 mA. This is sufficient to operate most sensors. If higher currents are required at the sensor output, a separate power supply can be connected.

- **Robust, field-compatible connections**

The three connections on the device – IO-Link, USB and optional supply voltage – are designed as robust and field-compatible M12 connections. This means that the interface can even be used in harsh environments.

- **Status LEDs**

Several status LEDs on the unit provide the user with a status overview and facilitate error localisation. For example, if the USB power supply is insufficient for a sensor, this is indicated by an LED.

- **Scope of supply**

In addition to the AL1060 IO-Link master, the set includes all connection cables required for operation (M12 B-coded for USB, M12 A-coded for sensor) as well as the LR DEVICE parameter setting software.

A wide-range power supply unit with different adapter plates for worldwide use is available as an option.

## Products

| Type  | Description  | Order no.     |
|---|--|---------------|
| <b>Included in the set</b>  |  | <b>ZZ1060</b> |
|    | IO-Link master USB 1 port  | <b>AL1060</b> |
|    | Connection cable M12 / M12, 1 m, PUR cable                             | <b>EVC012</b> |
|    | Connection cable M12 socket, B-coded / USB plug                        | <b>E12689</b> |
|    | LR DEVICE (USB stick), IO-Link parameter setting software              | <b>QA0011</b> |
| <b>Optional accessories</b>   |  |               |
|   | Plug-in power supply with interchangeable adapter, 230V/24V, worldwide | <b>E80121</b> |
|  | Plug-in power supply with interchangeable adapter, 230V/24V, Germany   | <b>E80120</b> |

## Technical data

| IO-Link master USB 1 port<br>AL1060        |        |              |
|--|--------|--------------|
| Sensor supply                              | [V DC] | 24           |
| Sensor supply - AUX<br>Current consumption | [mA]   | < 650        |
| Sensor supply - USB<br>Current consumption | [mA]   | < 150        |
| IO-Link version                            |        | 1.1          |
| USB version                                |        | 2.0          |
| Number of IO-Link A-ports                  |        | 1            |
| Number of binary inputs                    |        | 2            |
| Number of binary inputs                    |        | 2            |
| Protection rating                          |        | IP 65, IP 67 |



IO-Link

# Safety over IO-Link



PROFIsafe IO-Link module



**Safety module for IO-Link**

**8 safe OSSD inputs**

**4 powerful outputs with separate 24 V supply**

**PROFIsafe telegram tunnelled via IO-Link**

**Safety to SIL 3 and PLe**

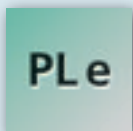

## IO-Link for safety-related applications

Thanks to the transmission protocol "PROFIsafe", standard safety sensors and actuators can be operated via IO-Link.

All you need is the PROFIsafe IO-Link module. It features 8 safe digital inputs (OSSD) and 4 safe outputs. The innovation: On the hardware side, the module is simply connected to a normal IO-Link master via IO-Link. The special PROFIsafe transmission telegram ensures a "tunneled" connection with the safety controller within the normal IO-Link communication. It fulfils the safety levels SIL 3 to IEC 61508 / EN 61508 and PLe to EN ISO 13849-1.

### Powerful safe outputs

A separate 24 V supply via L-coded M12 sockets enables connection of powerful actuators. The outputs can be configured as PNP or NPN.

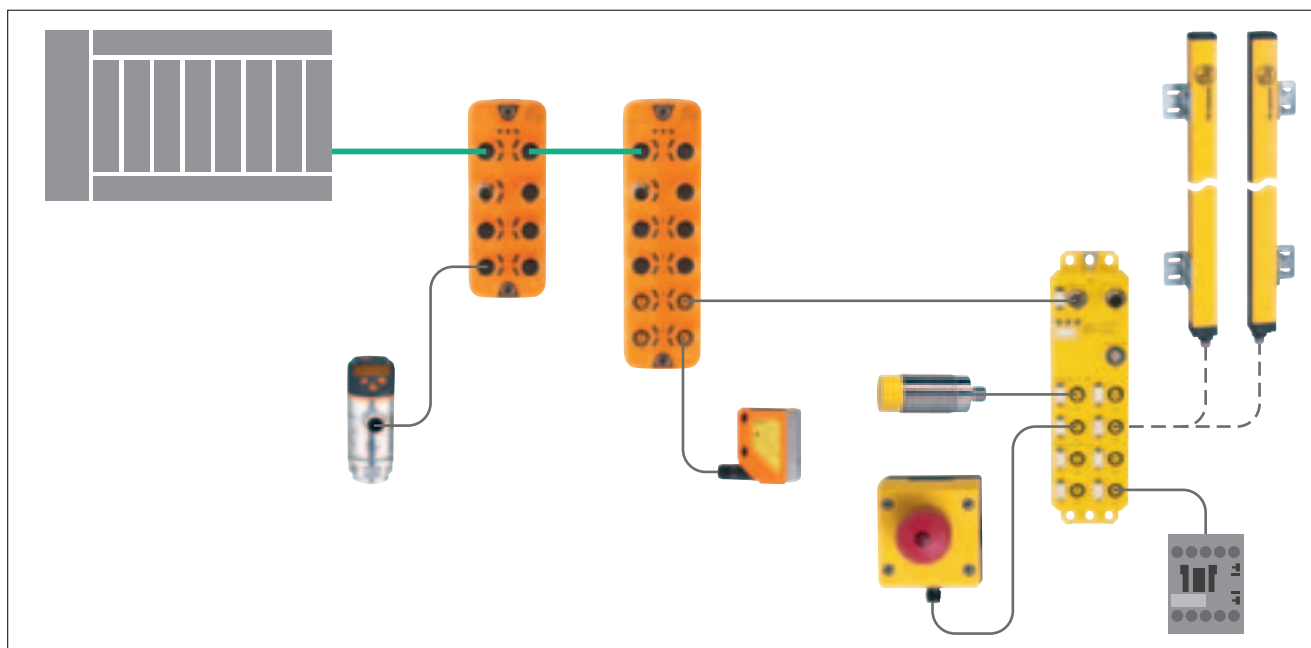

## Accessories

| Type | Description | Order no. |
|------|-------------|-----------|
|------|-------------|-----------|

| IO-Link master PerformanceLine Coolant |                  |        |
|--|------------------|--------|
|  | Profinet, 4-port | AL1400 |
|  | Profinet, 8-port | AL1402 |

| Accessories for AL2005 |                        |        |
|------------------------|------------------------|--------|
|                        | PROFIsafe address plug | E7700S |

| M12 socket, connection cable 2.5 mm <sup>2</sup> , L-coded (power) | M12 - open | M12 - M12     |
|--|------------|---------------|
|  | 1 m        | - E12653      |
|  | 2 m        | E12641 E12654 |
|  | 5 m        | E12642 E12655 |
|  | 10 m       | E12643 E12656 |

| M12 connection cable 0.34 mm <sup>2</sup> (sensor) |      |          |
|--|------|----------|
|  | 1 m  | - EVC042 |
|  | 2 m  | - EVC043 |
|  | 5 m  | - EVC044 |
|  | 10 m | - EVC493 |

| Wirable |                               |          |
|---------|-------------------------------|----------|
|         | M12 connector L-coded (power) | - E12673 |
|         | M12 socket L-coded (power)    | - E12672 |

On the hardware side, the PROFIsafe IO-Link module is connected to an A or B port of an AL1400 or AL1402 IO-Link master.

The safety module is powered via a separate L-coded M12 cable.

The "PROFIsafe" transmission protocol ensures tunnelled safety communication with the safety controller.

### Easy replacement of units through address plug

The PROFIsafe address plug E7700S enables simple and fast replacement of the AL2005 without a computer and without additional software. This memory plug is simply plugged into the new AL2005 and the stored PROFIsafe address is automatically transferred to the new PROFIsafe IO-Link module.

| Technical data PROFIsafe IO-Link module |        | Order no. AL2005                |
|---|--------|---------------------------------|
| Operating voltage                       | [V DC] | 19.2...30.2; (US; to SELV/PELV) |
| Additional voltage supply               | [V DC] | 19.2...30.2; (UA)               |
| <b>Actuator supply UA</b>               |        |                                 |
| Total current rating                    | [A]    | 6                               |
| Current rating per port                 | [A]    | 2                               |
| IO-Link version                         |        | 1.1                             |
| IO-Link transmission type               |        | COM3                            |
| Number of inputs / outputs              |        | 8 / 4                           |
| <b>Safety classification</b>            |        |                                 |
| 1-channel (ISO 13849-1)                 |        | PL d                            |
| 1-channel (IEC 61508)                   |        | SIL 2                           |
| 2-channel (ISO 13849-1)                 |        | PL e                            |
| 2-channel (IEC 61508)                   |        | SIL 3                           |
| Protection rating                       |        | IP 65, IP 67                    |
| Ambient temperature                     | [°C]   | -25...60                        |

We reserve the right to make technical alterations without prior notice. · 11.2020



IO-Link



# io-key – the key to the industrial IoT



IO-Link accessories



Pre-configured, no SIM card required

Web-based dashboard for visualisation and analysis of cloud data

Email or text message when limit values are exceeded

IO-Link sensor data is sent directly via mobile network to the cloud

Two IO-Link sensors can be connected

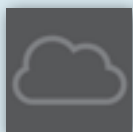
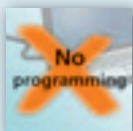
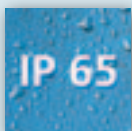

### Cloud connection for all IO-Link sensors

The io-key recognises up to two connected IO-Link sensors and sends their process values automatically via GSM mobile network to the cloud where the data is stored. The user can visualise and analyse the data via a web-based dashboard.

### Alarms are sent as a text message or email











A few mouse clicks suffice to set limit values in the dashboard, so that the plant operator will be warned by email or text message when values are exceeded or not reached.

### Export

The data from all sensors can be summarised and exported automatically as a report at any time.



## Accessories

| Type  | Description   | Order no.     |
|---|---|---------------|
|    | Plug-in power supply, 90...264 V AC / 24 V DC                               | <b>E80120</b> |
|   | Plug-in power supply with interchangeable adapter, 100...240 V AC / 24 V DC | <b>E80121</b> |
|    | Level sensor<br>0.1 m cable, M12 connector, 5 pins                          | <b>KQ1001</b> |
|    | Vibration diagnostics sensor for industrial machines                        | <b>VVB001</b> |
|    | Signal converter for PT100/PT1000 temperature sensors to IO-Link            | <b>TP9237</b> |
|    | Smart valve sensor<br>M12 connector   | <b>MVQ101</b> |
|  | IO-Link input module, 6 x 2 inputs; M12 connector; IP 67                    | <b>AL2340</b> |
|  | Thermal compressed air meter, G 1/4<br>0.05...15 Nm <sup>3</sup> /h         | <b>SD5500</b> |
|  | Evaluation system and display for analogue signals                          | <b>DP2200</b> |
| <b>Connection technology</b>  |   |               |
|  | Connection cable, M12, 1 m, black, PUR cable                                | <b>EVC042</b> |
|   | Connection cable, M12, 2 m, black, PUR cable                                | <b>EVC043</b> |
|  | Y connection cable, M12, 0,3 m, black, PUR cable                            | <b>EVC614</b> |

## Products

| Description                                      | Order no.     |               |
|--|---------------|---------------|
|  | Europe        | global        |
| <b>io-key version</b>                            |               |               |
| io-key, IIoT gateway for 2 IO-Link sensors       | <b>AIK001</b> | <b>AIK050</b> |
| Transmission interval XS<br>1 x per day          | <b>AIS910</b> | <b>AIS950</b> |
| Transmission interval S<br>1 x per hour          | <b>AIS911</b> | <b>AIS951</b> |
| Transmission interval M<br>1 x per minute        | <b>AIS912</b> | <b>AIS952</b> |
| Transmission interval L<br>every 10 seconds      | <b>AIS913</b> | <b>AIS953</b> |
| Edge alarm function<br>(up to 1000 alarms/month) | <b>AIS990</b> |               |
| SMS notification<br>(up to 10 SMS)               | <b>AIS991</b> |               |

### From sensor to IIoT

Sensor information can be collected directly and sent to the cloud without requiring any connection to a controller, PC or company network.

Apart from voltage supply and GSM network availability, the io-key requires no infrastructure.

ifm offers two versions of the io-key with different radio modules and data tariffs for European and global mobile networks.

As all ifm products, the io-key is a sturdy unit and has a high protection rating of IP 65. Hence, it can be used in harsh industrial environments.

### Application examples

The io-key is suited for all applications that do not primarily require permanent transmission of measured values in real-time.

The io-key can even be used to monitor and evaluate remote parts of the plant that are not connected to the company infrastructure.

For example:

- Tank monitoring using a capacitive continuous level sensor type KQ10xx
- Measurement of compressed air consumption and leakage monitoring using an compressed air meter type SDxxxx
- Fan monitoring using a vibration diagnostics sensor type VVBxxx
- Valve monitoring using a valve sensor type MVQxxx



# No compromises: robust UHF evaluation system for harsh environments.



RFID UHF



**Antenna, evaluation unit and switch, all in one device, reduces installation time.**

**Reads up to 16 tags at a distance of up to 3 meters.**

**Installation in metallic or wet environments is possible.**

**Fieldbus interface and digital inputs and outputs, minimise field wiring.**

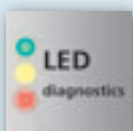
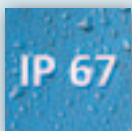

### So compact, so flexible

The new RFID UHF evaluation systems convince with their compact design and the maximum flexibility they offer. Complete with antenna, evaluation unit and switch, the hardware provides everything required for a quick and easy installation. What is more, the optimised operating principle of the system allows direct installation in metallic or wet environments – without any loss of performance.

### Transferring data over the network, controlling actuators directly

At maximum performance level, the antenna can detect up to 16 rapidly moving tags, at a distance of up to 3 m. The tag reading can be refined further via selective RSSI values. Using an additional fieldbus interface offers the possibility to directly connect another network point. The digital output can be used to control an actuator.





## Advantages of ifm's UHF RFID solution:

### Robust and expandable

Antenna, evaluation unit and interface are integrated in one compact, robust housing with protection rating IP 67. This makes the system perfectly suited for use in harsh industrial environments.

### Powerful antenna

Thanks to the internal antenna with circular polarisation, the device can be installed in metallic housings without reception being affected.

### Integrated web server

The evaluation systems have an integrated web server. Users log in via an HTTP address to get full access to the device set-up and, in case of cloud integration, to monitoring and diagnostic data.

### Universal interface

The UHF RFID evaluation units with their interfaces for Profinet, EtherNet/IP and TCP/IP are ideal for direct connection to PCs, industrial PCs or PLCs. Using an additional fieldbus interface, it is also possible to pass through signals and minimise field wiring.

### Additional digital inputs

The unit has two additional digital inputs and outputs. The inbuilt logic function can be used to provide additional control functionality directly, e.g. to immediately control a light tower when required.

### Applications

The benefits of the evaluation systems really come in to their own in track and trace and traceability applications. Thanks to the long ranges, for example, tags on vehicles with access rights can be detected and evaluated at a distance of up to 3 meters, after detection it is possible to control the barriers or gates directly from the unit. Without time consuming programming effort.

In intralogistics, the system is used for seamless product tracking. It is possible to read up to 16 tags simultaneously and the products can be clearly assigned to their designated storage stations or pallets. This ensures that the correct quantity of the correct product reaches its destination on time.

## Products

| Design                       | Description                                   | Order no.     |
|------------------------------|---|---------------|
| <b>PROFINET interface</b>    |   |               |
|                              | RFID UHF compact unit<br>865...868 MHz (ETSI) | <b>DTE801</b> |
|                              | RFID UHF compact unit<br>902...928 MHz (FCC)  | <b>DTE901</b> |
| <b>EtherNet/IP interface</b> |   |               |
|                              | RFID UHF compact unit<br>865...868 MHz (ETSI) | <b>DTE802</b> |
|                              | RFID UHF compact unit<br>902...928 MHz (FCC)  | <b>DTE902</b> |
| <b>TCP/IP interface</b>      |   |               |
|                              | RFID UHF compact unit<br>865...868 MHz (ETSI) | <b>DTE804</b> |
|                              | RFID UHF compact unit<br>902...928 MHz (FCC)  | <b>DTE904</b> |

Further country approvals and interfaces for IO-Link and IoT (cloud connection) are in preparation.

| <b>Mounting accessories for DTE801, DTE802, DTE804</b> |   |               |
|--|---|---------------|
|  | Mounting bracket,<br>1.4301 (stainless steel / 304) | <b>E80335</b> |
|  | Mounting plate,<br>1.4301 (stainless steel / 304)   | <b>E80336</b> |
|  | Mounting rod<br>1.4301 (stainless steel / 304)      | <b>E80337</b> |
| <b>Selection RFID transponders</b>                     |   |               |
|  | ID-TAG/R30X10/04 – 865...870 MHz, 96 bit            | <b>E80353</b> |
|  | ID-TAG/73.5X21.2/04 – 1000 pieces on reel           | <b>E80386</b> |
|  | ID-TAG/139 x 53 x 15/04                             | <b>E80393</b> |
|  | ID-TAG/174 x 70 x 17.6/04                           | <b>E80394</b> |

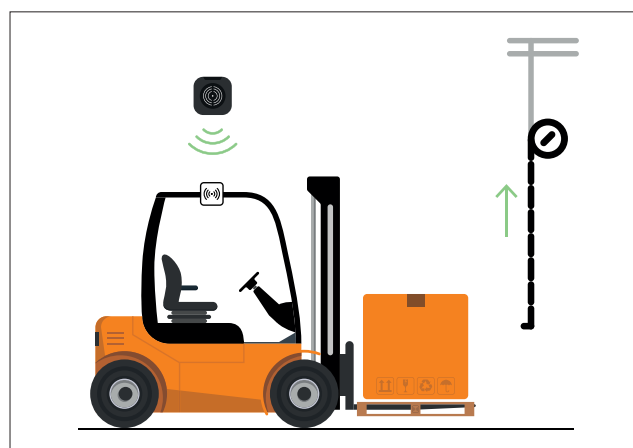

RFID solution for automated gate opening.



Systems for condition monitoring of machines

# Smart vibration monitoring without cabling



Systems for vibration monitoring and diagnosis



**Versatile use thanks to battery operation and radio transmission**

**For overall vibration and temperature monitoring in places that are difficult to access**

**Radio technology with intelligent mesh topology for efficient data transmission**

**Easy implementation from sensor to data visualisation**



## **Vibration monitoring for simple machines.**



The battery-operated VW vibration sensor in combination with the ZB0929 Gateway and LR SmartObserver enables overall monitoring of the machine condition according to ISO 10816. Together with the integrated temperature monitoring it is possible to detect imminent damage to machines and schedule demand-oriented maintenance to prevent major damage and costly downtimes.

## **Quick and easy integration thanks to wireless operation.**

With the completely wireless sensors and intuitive software for analysing and visualising the data, a comprehensive plant monitoring system is quickly set up without any extra work. While ensuring the highest level of data security, the sensor data is transmitted from the measurement point to the gateway.



## Accessories

| Design  | Type  | Order no.     |
|---|---|---------------|
| <b>Installation</b>   |   |               |
|  | M8 magnetic adapter   | <b>E30448</b> |
|  | Adhesive adapter, stainless steel, internal thread M8 x 1,25                            | <b>E30473</b> |
| <b>Connection technology</b>  |   |               |
|  | Ethernet jumper, cross-over patch cable 2 m, PVC cable, RJ45 connector / RJ45 connector | <b>EC2080</b> |

The vibration sensor detects and transmits both the v-RMS value and the recorded temperature at the measurement point. Below is additional information on the data provided as well as on the transmission capabilities.

### v-RMS (fatigue)

Effective value of the vibration velocity. Enables an assessment of component fatigue.

### Temperature

A temperature increase can be caused by excessive friction or other effects (e.g. electrical causes) and is an indicator of existing or imminent defects.

### Comfortable, intelligent connectivity

In addition to an Ethernet interface via cable, the ZB0929 Gateway also offers a variety of wireless connection options like NB-IoT, LTE CAT 1, Wi-Fi and 2G GSM.

Up to 30 sensors can be connected to the Gateway and thus to the backend system indirectly or by using an intelligent mesh communication at the mere push of a button.



### Evaluation

The sensor data can be visualised and analysed via LR SmartObserver, moreover, alarms can be conveniently configured so that a quick set-up of the entire measuring chain is ensured. Appropriate licenses are mandatory for evaluating the sensor data.

### Without external power supply

Thanks to the built-in battery, the sensor can be operated for at least 4 years. As the electronics is completely potted, unwanted resonance vibrations are excluded.

## Products

| Design  | Type  | Order no.     |
|---|---|---------------|
|  | Wireless vibration sensor<br>1 measurement axis | <b>VWV001</b> |
|  | Wireless vibration sensor<br>3 measurement axes | <b>VWV002</b> |
|  | Gateway for wireless vibration sensors, IP 20   | <b>ZB0929</b> |

### Common technical data VWV001, VWV002

|                     |        |                    |
|---------------------|--------|--------------------|
| Measuring range     | [mm/s] | 0...25             |
| Frequency range     | [Hz]   | 10...1000          |
| Ambient temperature | [°C]   | -40...85           |
| Protection rating   |        | IP 68              |
| Communication       |        | 2.4 GHz (ISM band) |

### Technical data ZB0929

|                         |        |                          |
|-------------------------|--------|--------------------------|
| Operating voltage       | [V DC] | 5 (ZB0929)               |
| Topology                |        | Mesh network             |
| Communication via cable |        | Ethernet (TCP/IP)        |
| Wireless communication  |        | LTE CAT 1, Wi-Fi, NB-IOT |

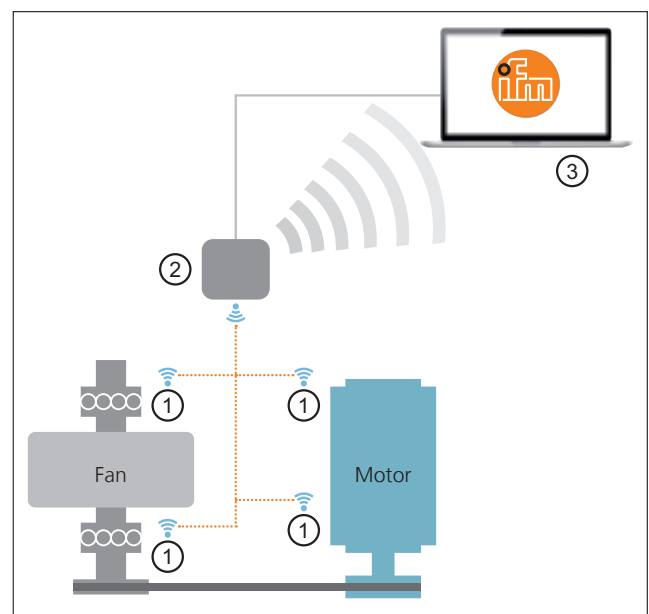

- 1) VW Vibration sensor
- 2) ZB0929 Gateway
- 3) LR SmartObserver



Systems for mobile machines

# ioControl – rugged I/O module with integrated controller



I/O modules



I/O module for mobile applications with high protection rating and DEUTSCH connectors or M12 connectors.

Can be used as independent, CODESYS-programmable mini controller

Display and keyboard interface for parameter setting

Configurable input/output function

Two CAN interfaces with CANopen and J1939 protocol

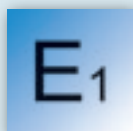
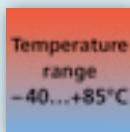
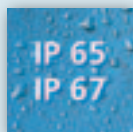
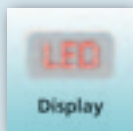

## Decentralised I/O module and mini controller in one unit

ioControl is a decentralised I/O module connected to the controller via CAN bus. It is installed away from the controller on remote machine parts right where the signals are generated. The high protection rating makes it suitable for outdoor installation in wet and dirty areas.

DEUTSCH connectors or alternatively M12 connectors, which are widely used in mobile automation, ensure an easy and safe connection of sensors and actuators. Networking of the CAN bus is effected via prewired drop cables. ioControl can either be used as a configurable I/O module or as a mini controller in the field. CODESYS is used as a programming system.



## Features and benefits

The decentralised I/O modules of the ioControl system connect binary and analogue sensors to a controller via CAN bus using the CANopen protocol. Furthermore, I/O modules provide additional functions for signal preprocessing.

The compact, glass-fibre reinforced housing features reverse-polarity protected DEUTSCH connectors or M12 connectors suitable for mobile use, providing all the necessary connections for inputs, outputs, communication and programming. An integrated two-colour LED display with keyboard serves to indicate the most important system messages, the baud rate and the node number as well as for device configuration. An extensive range of connection cables completes the offer.

### • Configurable inputs and outputs

A high degree of flexibility is provided by the configurable inputs and outputs. There is a choice of analogue and digital inputs. The analogue inputs can be set as current inputs (0...20 mA) or voltage inputs (0...10 V / 0...32 V).

For digital and analogue I/O modules, the profile DSP 401 has been defined. The input/output functions of the module are configured via the device object directory.

### • The electronics

The core of the controller, which has been designed according to the applicable standards for electronics in mobile applications, is a modern 32-bit processor. Its monitoring and protective functions enable reliable operation even under extreme operating conditions.

### Programmable to IEC 61131-3 with CODESYS

Apart from their application as I/O modules, all units can also be used as freely programmable mini controllers with CANopen and J1939 among others. Programming is done via CODESYS by means of the standardised IEC 61131-3 languages, allowing the user to build the application software with ease. In addition, libraries are available for special functions of the controller.

### • Communication interfaces

ioControl is equipped with two CAN interfaces to ISO 11898 for programming and data exchange with connected modules, controllers, displays or an engine controller.

## Products

| ioControl | Order no. |        |        |
|-----------|-----------|--------|--------|
| M12       | CR2040    | CR2041 | CR2042 |
| DEUTSCH   | CR2050    | CR2051 | CR2052 |

### Number of inputs (can be configured)

|  |   |   |   |
|--|---|---|---|
| Analogue multifunctional/digital           | 8 | – | – |
| Analogue multifunctional/frequency/digital | – | – | 4 |
| Frequency/digital                          | 4 | – | – |
| Resistance/digital                         | 4 | – | 4 |

### Number of outputs (can be configured)

|                    |   |   |   |
|--------------------|---|---|---|
| PWMI/digital 4.0 A | – | 4 | 4 |
| PWM/digital 4.0 A  | – | 4 | – |
| PWMI/digital 2.5 A | – | 4 | 4 |
| PWM/digital 2.5 A  | – | 4 | – |

### Common technical data – ioControl

|                                     |                                   |  |
|-------------------------------------|-----------------------------------|--|
| Housing                             | impact-resistant polyamide        |  |
| Device connection                   | inputs/outputs<br>CAN interface 1 | 6 poles<br>(Deutsch DT04-6p)<br>or 5-pole<br>(M12 connector)   |
|                                     | supply voltage<br>CAN interface 2 | 6 poles<br>(Tyco/AMP)  |
| Protection                          | IP 65, IP 67                      |  |
| Operating voltage                   | [V DC]                            | 8...32   |
| Current consumption                 | [mA]                              | ≤ 200<br>(without external load)   |
| Temperature range operation/storage | [°C]                              | -40...85   |
| Interfaces                          | CAN                               | 2.0 A/B CiA DS 301 V4,<br>CiA DS 401 V 1.4<br>ISO 11898,<br>20 Kbits/s...1 Mbit/s<br>(default 250 Kbits/s) |
| Protocols                           | CAN                               | CANopen, SAE J 1939<br>or free protocol  |
| Programming                         | CODESYS V 2.3                     |  |
| Total memory                        | 1536 kBytes                       |  |
| Application memory                  | 512 kBytes                        |  |
| Standards and tests (extract)       | CE, E1 (UN-ECE R10),<br>EN 50 155 |  |

## Accessories

| Description                                  | Order no. |        |
|--|-----------|--------|
|  | DEUTSCH   | M12    |
| Connection cable for 1 input, 2 m            | E12544    | EVM085 |
| Connection cable for 2 inputs, 2 m           | E12562    | EVM093 |
| Connection cable for 1 output, 2 m           | E12550    | EVM085 |
| Connection cable, CAN, 1m                    | E12556    | EVC953 |
| Connection cable, AMP for module supply, 2 m | E12565    |        |
| CAN programming interface CANfox             | EC2112    |        |
| Adaptor set CAN/RS232 for CANfox             | EC2113    |        |





Systems for mobile machines

# ecomatPanel: robust, multifunctional input module



Units for operation and monitoring



**Rotary button with integrated 4-way button and push function**

**6 RGB backlit function keys and one segmented LED ring**

**All lighting elements can be controlled individually in any colour**

**Communication via CAN interface**

**For 12 and 24 V on-board power supplies**

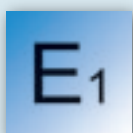
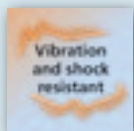

### Safe operation in rough environments

The ecomatPanel has been designed for use in the harsh environment in driver's cabins. The rotary button and the function keys are large enough to ensure easy handling even when wearing gloves. The rotary button is also equipped with a 4-way button (up/down/left/right). This makes it possible to quickly navigate through setting menus. Another switching function can be triggered by pushing the rotary button (push function).

### Colour feedback

The illuminated ring around the rotary button, consisting of four segments, as well as the illuminated keys provide a clear overview of the set functions. All LED lighting elements can be set separately and assigned individual colours.





## Easy integration into panels



### CAN interface

Communication is effected via the integrated CAN interface. Via this interface, the individual LED segments are controlled and the status of the keys and the operating head is queried.

### Plug & play with ifm displays

The ecomatPanel has been designed for direct communication with the ifm dialogue modules for mobile applications (ecomatDisplays). Once the dialogue module has been connected via CAN bus, the keys and LEDs of the ecomatPanel can be evaluated directly in the application program and be used for the operating functions of the display.

The innovation: No programming of the communication interface is required.

### Designed for robust applications

The ecomatPanel can be used in 12 V and 24 V on-board networks.

The high protection rating IP 65 and the closed surface provide protection even under adverse environmental conditions. Even extreme temperatures or permanent shock and vibration do not affect the functions of the ecomatPanel.

## Products

| Description                         | Order no.     |
|-------------------------------------|---------------|
| <b>Devices</b>                      |               |
| ecomatPanel                         | <b>CR1300</b> |
| ecomatPanel, segmented LED ring     | <b>CR1301</b> |
| <b>Accessories</b>                  |               |
| Mounting frame                      | <b>EC1300</b> |
| Connection cable, 4 poles, 5m       | <b>E12736</b> |
| Connector, 4 poles, single contacts | <b>E12737</b> |

| Technical data ecomatPanel    |                           |   |
|-------------------------------|---------------------------|---|
| Installation                  | Panel mounting            |   |
| Dimensions [mm]               | 136 x 86 x 73.5           |   |
| Ambient temperature [°C]      | -40...85                  |   |
| Storage temperature [°C]      | -40...85                  |   |
| Protection rating             | IP 65                     |   |
| Operating voltage [V DC]      | 9...32                    |   |
| Nominal voltage [V DC]        | 12 / 24                   |   |
| Max. current consumption [mA] | 400                       |   |
| Reverse polarity protection   | •                         |   |
| CAN interfaces                | Number                    | 1   |
|                               | Protocol                  | J1939                                     |
|                               | Default baudrate [Kbit/s] | 250                                       |
|                               |                           | 135                                       |
|                               |                           | (dynamic address assignment is supported) |
| Connector                     | Tyco 1-967640-1, 4 poles  |   |

| Display / operating elements |  |
|------------------------------|--|
| Keys                         | 6 function keys (silicone keyboard) with tactile feedback, freely programmable (softkey function)                                  |
| Key background illumination  | RGB LED (brightness adjustable)  |
| Rotary button                | 24 stops per revolution with push function and joystick function in two axes   |
| LED ring, segmented          | <b>CR1300:</b> not included<br><b>CR1301:</b> around the rotary button, divided in 4 segments with RGB LED (brightness adjustable) |

We reserve the right to make technical alterations without prior notice. · 11.2020



Systems for mobile machines

# 3D collision warning system for mobile machines



Cameras for mobile applications



**Robust driver assistance system for the detection of obstacles in the path**

**Early detection of reflectors, e.g. persons with safety vests**

**Early warning of potentially dangerous situations to the driver**

**Ideal for new machines and for retrofitting to existing machines**

**Ready-to-start application package with easy set-up**

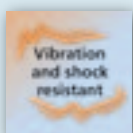
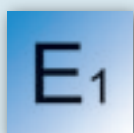
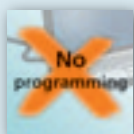
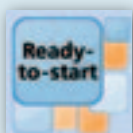

## Easy retrofitting

The 3D collision warning system is based on the established 3D sensors from ifm. It precisely detects obstacles and visualises them in a 2D image on a monitor. This keeps the driver informed about the trigger of the alarm and the area to be monitored at all times. Thanks to powerful algorithms, false tripping is virtually excluded. The system is set up easily via the supplied operating display, no PC is required.

## Ready-to-start application package

The set includes all components to set up a fully functioning collision warning system on a mobile machine, e.g. a fork lift, wheel loader, excavator, reach stacker or transport vehicle within a few minutes.



## Features and benefits

### Accident prevention

The driver can have poor visibility of some areas around the machine which can lead to dangerous situations. Further accident risks result from time pressure or fatigue of the machine operator. The ifm driver assistance system, which supports the daily work of the driver, provides the remedy.

### Active obstacle detection

The active obstacle detection developed by ifm monitors six danger zones around the vehicle and warns the driver of imminent collisions in good time. For this purpose, a tried-and-tested 3D time-of-flight system from ifm is used which reduces false alarms to a minimum thanks to a sophisticated algorithm. Warnings are provided visually, acoustically and in the form of icons via the supplied 7" monitor.

### Detection of reflective clothing

Thanks to a special classification of reflective materials, e.g. reflective vests or clothing, the collision warning for persons can be given priority over other objects. This increases the safety of persons.



### Retrofit set for mobile machines

The innovation: The driver assistance system is provided as a ready-to-start application package. It contains all necessary components including any cables and mounting accessories. This means it can be easily retrofitted on all mobile machines with 24 V on-board system voltage\*.

### Easy set-up

After mechanical installation of the system and plug & play wiring, set-up is carried out within a few minutes via the supplied colour display. Only a few parameters are required in the intuitive set-up process. Then the system is ready for operation.

\* Please contact our service centre if you have a different on-board system voltage.

## Products

| Description   | Order no.     |
|---|---------------|
| <b>Ready-to-start application package (complete set)</b>  |               |
| Area surveillance with collision warning  | <b>ZZ1103</b> |
| <b>Application package (individual components)</b>  |               |
| Mobile 3D smart camera with integrated 2D/3D overlay (The article is pre-programmed especially for the application package. If mobile camera is purchased on its own, there is no pre-programming.)                                       | <b>O3M261</b> |
| IR system illumination unit   | <b>O3M960</b> |
| U-shaped bracket, suitable for 3D camera or illumination unit, stainless steel, black (application package contains 2 pieces)   | <b>E3M102</b> |
| MCI cable, connection sensor / system illumination unit, 0.25 m   | <b>E3M120</b> |
| Voltage supply system illumination unit, socket, M12, 10 m PUR cable, 4 poles   | <b>E3M133</b> |
| BasicController, programmable controller with multi-functional input and output channels (The article is pre-programmed especially for the application package. If BasicController is purchased on its own, there is no pre-programming.) | <b>CR0403</b> |
| CAN adapter cable for the connection and voltage supply of O3M, CR0403 and CR0451, 10 m   | <b>E3M171</b> |
| Upper part of the housing for CR0403, suitable for installation of the CR0451 display   | <b>EC0402</b> |
| Adapter cable for the connection of the buzzer to CR0403 and use of the output channels   | <b>E3M172</b> |
| BasicDisplay, programmable graphic display with CAN connection (The article is pre-programmed especially for the application package. If BasicDisplay is purchased on its own, there is no pre-programming.)                              | <b>CR0451</b> |
| 7" TFT LCD monitor with LED backlight, 1 video input for display of the camera image  | <b>E2M231</b> |
| Bracket for monitor E2M231  | <b>E2M239</b> |
| Video extension cable, M16 connector / M16 socket, 5 m, black, PCV cable  | <b>E2M203</b> |
| Video adapter cable M12 connector / M16 connector for the connection of O3M261 to E2M231  | <b>E3M161</b> |
| Buzzer for connection to CR0403   |               |

### Extended functionality

For special requirements, expert settings are available during set-up. Pre-programmed inputs and outputs are available for an additional signal light, buzzers, standby operation or the ready status of the system.

### Suitable for robust applications

The 3D sensors are suitable for robust applications in indoor and outdoor areas. A high protecting rating and shock and vibration resistance as well as a wide temperature range meet all requirements for use in mobile machines.



# ecolink M12, Ethernet D-Code for industrial applications



Industrial applications /  
factory automation



**Halogen-free and silicone-free**

**Optimum sealing even  
when fastened by hand**

**Permanent vibration protection  
with saw tooth contour**

**Protection rating IP 65, IP 67**

**Ethernet CAT 5 / CAT 5e**

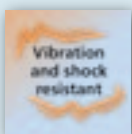
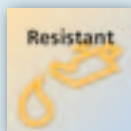

## ecolink M12 for demanding applications

Most applications require special solutions. Only high-quality materials, assured production processes and faultless assembly lead to success in the long run.

The asymmetrically acting vibration protection holds the M12 screw connection tight in its position, guaranteeing optimum and permanent sealing.

No tools are needed for installation and removal as this can be done manually without any problem.

High-quality materials especially suited to the application and intensive monitoring during and after production guarantee maximum quality standards.



### Technical data:

Operating voltage: 30 V AC / 60 V DC  
 Nominal current: 4 A  
 Protection rating: IP 65, IP 67  
 in locked condition with the matching counterpart.  
 Tightening torque  
 Threaded sleeve: 0.6 Nm – 1.2 Nm  
 Note the maximum value of the counterpart  
 Ambient temperature: -25...90 °C  
 Drag chain: > 3 million bending cycles

### Materials:

Housing / moulded body: TPU  
 Coupling nut: brass  
 Contacts: Gold-plated

### Cable:

PUR, halogen-free, silicone-free  
 4 x 0.34 mm<sup>2</sup> (7 x Ø 0.25 mm), Ø 6.5 mm

### Approvals:

UL approval in preparation

### Applications: industrial applications

### Dimensions

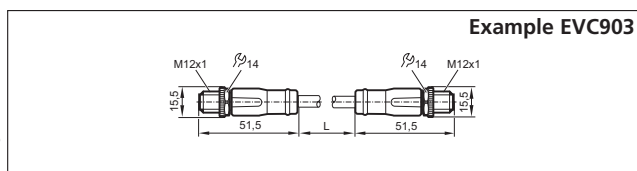
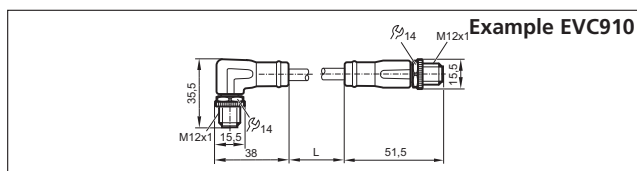
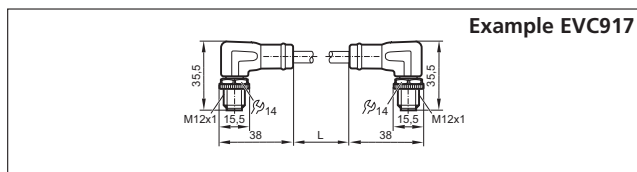
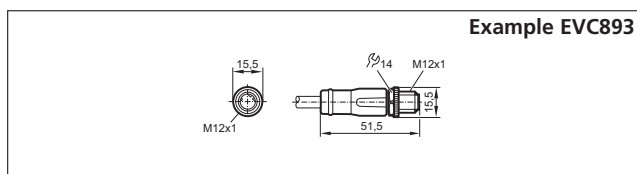
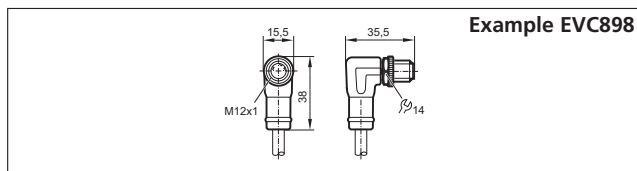

### Products

| Design | Description | Order no. |
|--------|-------------|-----------|
|--------|-------------|-----------|

#### M12 cable plug · 4 poles · straight

|  |        |        |
|--|--------|--------|
|  | 2.0 m  | EVC893 |
|  | 5.0 m  | EVC894 |
|  | 10.0 m | EVC895 |
|  | 20.0 m | EVC896 |
|  | 50.0 m | EVC897 |

#### M12 cable plug · 4 poles · angled

|  |        |        |
|--|--------|--------|
|  | 2.0 m  | EVC898 |
|  | 5.0 m  | EVC899 |
|  | 10.0 m | EVC900 |
|  | 20.0 m | EVC901 |
|  | 50.0 m | EVC902 |

#### M12 connection cable · 4 poles · straight-straight

|        |        |        |
|--------|--------|--------|
|        | 0.25 m | EVC903 |
|        | 0.5 m  | EVC904 |
|        | 1.0 m  | EVC905 |
|        | 2.0 m  | EVC906 |
|        | 5.0 m  | EVC907 |
|        | 10.0 m | EVC908 |
| 20.0 m | EVC909 |        |

#### M12 cable plug · 4 poles · straight-angled

|        |        |        |
|--------|--------|--------|
|        | 0.25 m | EVC910 |
|        | 0.5 m  | EVC911 |
|        | 1.0 m  | EVC912 |
|        | 2.0 m  | EVC913 |
|        | 5.0 m  | EVC914 |
|        | 10.0 m | EVC915 |
| 20.0 m | EVC916 |        |

#### M12 connection cable · 4 poles · angled-angled

|        |        |        |
|--------|--------|--------|
|        | 0.25 m | EVC917 |
|        | 0.5 m  | EVC918 |
|        | 1.0 m  | EVC919 |
|        | 2.0 m  | EVC920 |
|        | 5.0 m  | EVC921 |
|        | 10.0 m | EVC922 |
| 20.0 m | EVC923 |        |

### Wiring diagram

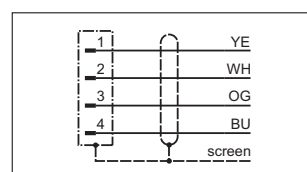

Example EVC898

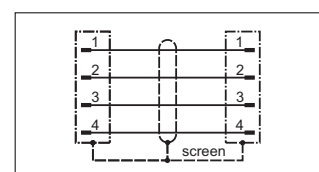

Example EVC917

We reserve the right to make technical alterations without prior notice. · 04.2021





Connection technology

# ecolink M12 / RJ45: Ethernet cables for industrial applications



Industrial applications /  
factory automation



**Halogen-free and silicone-free**

**Optimum sealing even  
when fastened by hand**

**Permanent vibration protection  
with saw tooth contour**

**Protection rating IP 65, IP 67**

**Ethernet CAT 5 / CAT 5e**

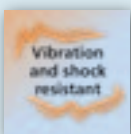
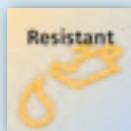

## ecolink M12 for demanding applications

Most applications require special solutions. Only high-quality materials, assured production processes and faultless assembly lead to success in the long run.

The asymmetrically acting vibration protection holds the M12 screw connection tight in its position, guaranteeing optimum and permanent sealing.

No tools are needed for installation and removal as this can be done manually without any problem.

High-quality materials especially suited to the application and intensive monitoring during and after production guarantee maximum quality standards.





### Technical data:

Operating voltage: 30 V AC / 60 V DC  
 Nominal current: 1.5 A  
 Protection rating: IP 65, IP 67 (M12 connector)  
 in locked condition with the matching counterpart.  
 RJ45 connector: IP 20  
 Tightening torque  
 Threaded sleeve: 0.6 Nm – 1.2 Nm  
 Note the maximum value of the counterpart  
 Ambient temperature:  
 M12 connector: -25...90 °C  
 RJ45 connector: -40...70 °C  
 Drag chain: > 3 million bending cycles

### Materials:

Housing / moulded body:  
 M12 connector: TPU  
 RJ45 connector: PC  
 Coupling nut: brass

### Cable:



PUR, halogen-free, silicone-free  
 4 x 0.34 mm<sup>2</sup> (7 x Ø 0.25 mm), Ø 6.5 mm

### Approvals:

UL approval in preparation

Applications: industrial applications

### Products

| Design   | Description | Order no. |
|--|-------------|-----------|
| <b>Connection cable · connector M12 straight / connector RJ45</b>                  |             |           |
|   | 0.5 m       | EVC924    |
|  | 1.0 m       | EVC925    |
|  | 2.0 m       | EVC926    |
|  | 3.0 m       | EVC936    |
|  | 5.0 m       | EVC927    |
|  | 6.0 m       | EVC937    |
|  | 10.0 m      | EVC928    |
|  | 12.0 m      | EVC938    |
|  | 20.0 m      | EVC929    |
| <b>Connection cable · connector M12 angled / connector RJ45</b>                    |             |           |
|  | 0.5 m       | EVC930    |
|  | 1.0 m       | EVC931    |
|  | 2.0 m       | EVC932    |
|  | 5.0 m       | EVC933    |
|  | 10.0 m      | EVC934    |
|  | 20.0 m      | EVC935    |

### Dimensions

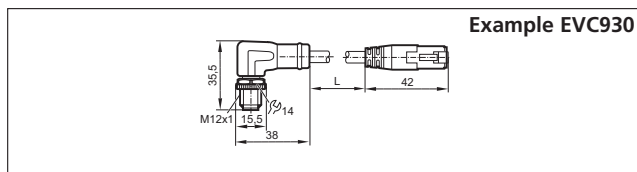
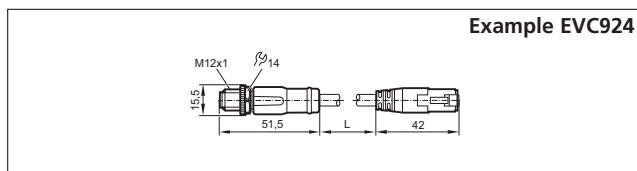

### Wiring

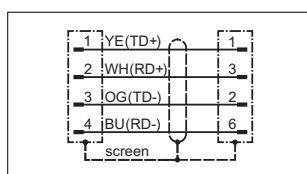

Example EVC924

We reserve the right to make technical alterations without prior notice. · 04.2021



Connection technology

# M12 CAN cables ecolink for mobile machines



For use in mobile and  
robust applications



**Large cable cross-section for  
voltage drop reduction**

**Permanent vibration protection  
due to saw tooth contour**

**Optimum sealing even when  
fastened by hand**

**The mechanical end stop  
protects the O-ring against  
destruction**

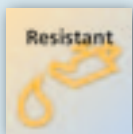
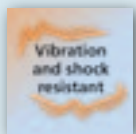
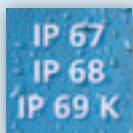

## Maximum reliability for mobile applications

The increased cable cross-section of 2 x 0.75 mm<sup>2</sup> (voltage supply) and 2 x 0.5 mm<sup>2</sup> (CAN) allows for transmission of high currents with low voltage drop and for reliable data transfer.

The integrated end stop protects the O-ring against destruction caused by over-tightening the nut. No tools needed for installation and removal by hand. The asymmetrically acting vibration protection holds the nut tight in its position, guaranteeing optimum and permanent sealing. High-quality materials and intense monitoring during and after the production guarantee the highest quality standard.

Therefore, these CAN cables are perfectly suited for robust indoor and outdoor applications on vehicles and mobile machines.



### Technical data:

Operating voltage: 30 V AC / 36 V DC  
 Current rating: 4 A  
 Protection rating: IP 65, IP 67, IP 68, IP 69K  
 in locked condition with the matching counterpart.  
 Tightening torque: 0.6 Nm – 1.5 Nm  
 Vibration / shock: 750 g, 1 million cycles

### Cable:

Drain wire (screen): 0.75 mm<sup>2</sup>  
 Voltage supply: 2 x 0.75 mm<sup>2</sup>  
 CAN: 2 x 0.5 mm<sup>2</sup>  
 Drag chain: > 5 million cycles

### Approvals:

cULus

### Applications:

EVC factory automation, machine tool industry;  
 use in mobile machines

### Dimensions

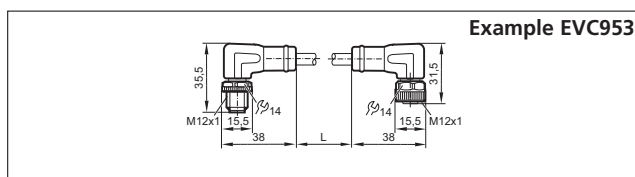
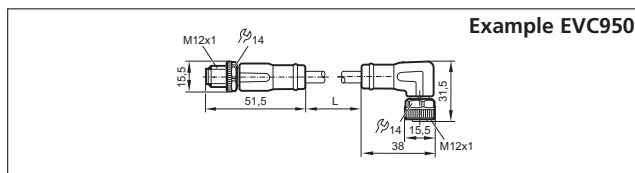
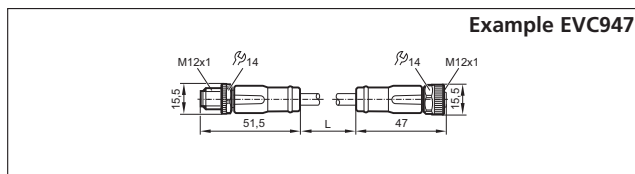

### Wiring diagram

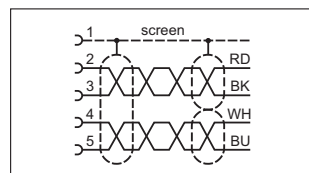
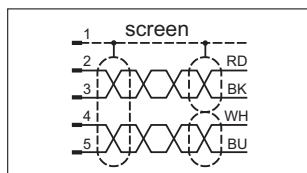

### Products

| Type  | Description | Order no. |
|---|-------------|-----------|
| <b>Connection cable M12 connector</b>   |             |           |
|   | 2.0 m       | EVC943    |
|   | 5.0 m       | EVC944    |
|   | 2.0 m       | EVC945    |
|   | 5.0 m       | EVC946    |
| <b>Connection cable M12 socket</b>  |             |           |
|   | 2.0 m       | EVC939    |
|   | 5.0 m       | EVC940    |
|   | 2.0 m       | EVC941    |
|   | 5.0 m       | EVC942    |
| <b>Connection cable with terminating resistor 120 Ω, M12 socket</b>                 |             |           |
|   | 2.0 m       | EVC957    |
|   | 5.0 m       | EVC958    |
|   | 2.0 m       | EVC959    |
|   | 5.0 m       | EVC960    |
|   | 10.0 m      | EVC961    |
|   | 10.0 m      | EVC961    |
| <b>Connection cable M12 connector / M12 socket</b>                                  |             |           |
|   | 1.0 m       | EVC947    |
|   | 2.0 m       | EVC948    |
|   | 5.0 m       | EVC949    |
| <b>Connection cable M12 connector / M12 socket</b>                                  |             |           |
|   | 1.0 m       | EVC950    |
|   | 2.0 m       | EVC951    |
|   | 5.0 m       | EVC952    |
| <b>Connection cable M12 connector / M12 socket</b>                                  |             |           |
|   | 1.0 m       | EVC953    |
|   | 2.0 m       | EVC954    |
|   | 5.0 m       | EVC955    |
|   | 10.0 m      | EVC956    |
| <b>Connection cable with terminating resistor 120 Ω, M12 connector / M12 socket</b> |             |           |
|   | 2.0 m       | EVC962    |
|   | 5.0 m       | EVC963    |
|   | 10.0 m      | EVC964    |
| <b>Connection cable with terminating resistor 120 Ω, M12 connector / M12 socket</b> |             |           |
|   | 2.0 m       | EVC965    |
|   | 5.0 m       | EVC966    |
|   | 10.0 m      | EVC967    |

We reserve the right to make technical alterations without prior notice. · 11/2020

# Who says we can only do hardware?

moneo. The all-you-want software for industrial evolution.

One thing is clear: proper industrial digitisation begins with the sensor and extends into the IT structure. If you are already using IO-Link in your plant, you have taken the first important step towards more efficiency and less unplanned downtime. And you are ready for the second step. You are ready to get even more out of your plant with the help of simple and ingenious software.

## Turning values into added value

With moneo, you can easily access the entire IO-Link network. And, thanks to the logical tree structure, you will have quick and efficient access to each individual sensor at any time. As soon as your IO-Link network is integrated into moneo, values will no longer be just separate pieces of information.

moneo makes values useful and transforms them into added value. You can, for example, combine the level values of all tanks into one overall stock figure. This overall stock figure can then be clearly displayed along with other relevant information in the cockpit.

This gives you a continuous overview of all the important values in your plant or process. If things become critical in your absence, for

example because the level is running low or the vibration on a fan rotor is dangerously increasing, moneo will immediately alert and inform you by e-mail or text message. This allows you to schedule maintenance in good time or initiate manual refill processes to keep things moving. In short: moneo will optimise your processes and ensure that they will be trouble-free.

## A new kind of flexibility thanks to moneo

As you have seen, moneo leaves nothing to be desired. It is a great piece of software to begin with, but its actual extent will always depend on your specific requirements. You can, for example, simply begin with parameter setting and the cockpit function for one part of your plant and explore the possibilities of real-time maintenance later, when you are ready for the next step.

**To put it in a nutshell:** moneo offers the flexibility to simply grow with your requirements. The days of unmanageable, oversized and confusing software are over. It is time for simplicity, user-friendliness and ingenuity. It is time for moneo!



|appliance



|starterkit



**moneo|appliance** is the hardware component that is precisely tailored to the requirements of the software and acts as a powerful, reliable node in the network infrastructure. It provides the software modules with the necessary computing power, stores and backs up data and serves as an interface for software updates and system maintenance. moneo|appliance can be used without high-level IT skills and can be integrated into the manufacturing environment, in the production network and in the computing centre.



**moneo|starterkit** brings condition monitoring for motors on fans, pumps and many other machines to a new level. The complete package based on well-coordinated hardware and software enables you to keep an eye on the condition of your system and to plan maintenance requirements in advance. And it's more user-friendly and convenient than ever. **In short:** The moneo|starterkit is the perfect start into digital evolution.



## moneo|OS



**moneo|OS** is the convenient software basis and management tool for all software products of the moneo IIoT toolkit. In moneo|OS, you can easily manage your moneo licences. In addition, the intelligent, easy-to-use data flow model enables you to combine individual pieces of sensor data into meaningful values. This makes it possible to quickly analyse and optimise your processes.





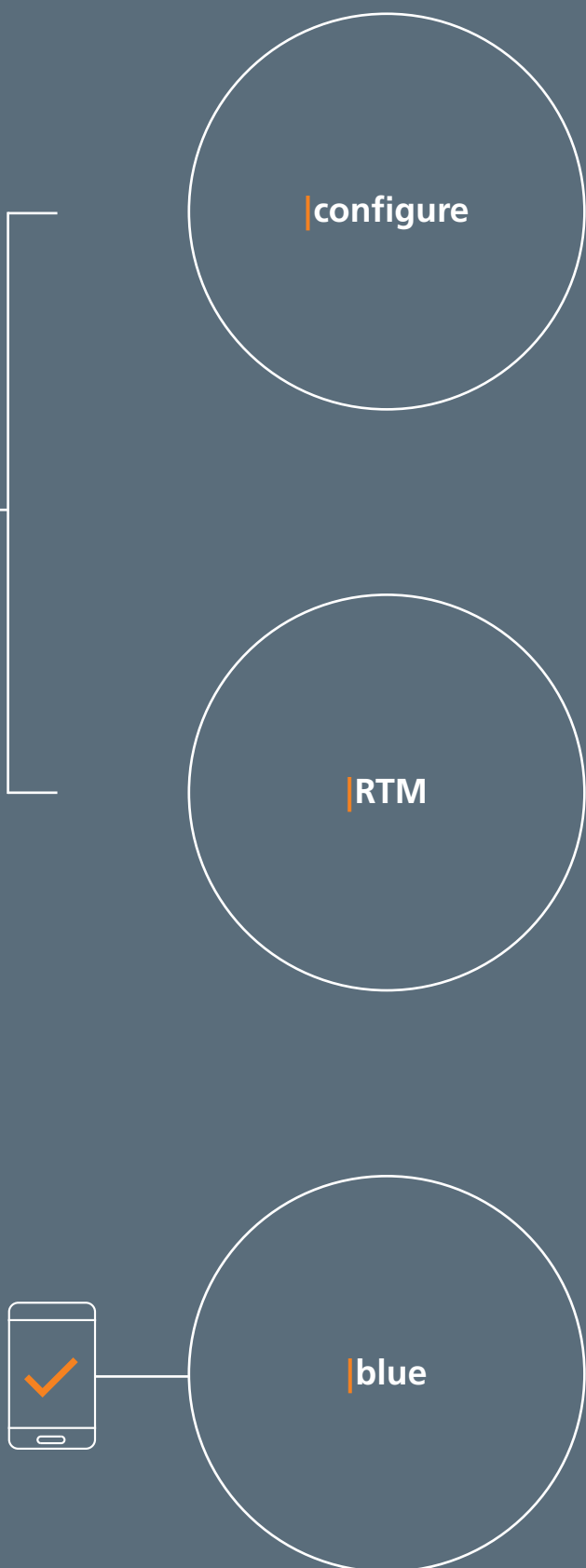

**moneo|configure** is the convenient management tool for your IO-Link network. Set the parameters of the IO-Link devices in your machines with just a few clicks. The visualisation in the cockpit facilitates both set-up and error diagnostics. The user-friendly parameter data set management contributes to speeding up new sensor integration.

**moneo|configure SA** The management tool is also available as a stand-alone version for those who wish to configure parameters easily via IO-Link.



**moneo|RTM** The advantages of powerful and transparent condition monitoring with moneo|RTM are obvious: less downtime, more efficient maintenance planning and detailed data analysis. This is how efficient maintenance works with the objective to implement cost-optimised production processes.



**moneo|blue** Quickly check sensor values while walking through the plant and simply adjust parameters on site. The free moneo|blue app makes this possible in combination with the Bluetooth Multi-Plug. Simply connect the plug to an IO-Link master and you will have access to the sensors connected to it. The app can, of course, also manage multiple plugs. It couldn't be any easier.



# We love it when a plan comes together.



**moneo|RTM: level monitoring in containers with 2-component casting resin.**

In order to protect the electronics of the sensors from shock, vibration and moisture, potting processes are an essential part of sensor production. For a smooth production process, but also for a constantly high product quality, permanent availability of casting resin and casting hardener in the storage tank containers is essential. The level monitoring application implemented at ifm prover gmbh thus contributes to a reliable logistics organisation of temperature-critical media in the production process.



**moneo|RTM: vibration monitoring on fans of an extraction system.**

In various production processes of ifm prover gmbh, an exhaust air system permanently guarantees and secures the quality of the products, machine uptime and high air quality. The fan capacity is therefore a relevant factor in the entire production process.



**moneo|RTM: consumption monitoring for sustainably optimised processes.**

In production, cooling water is provided, for example, for cooling of lasers. A decreasing cooling capacity, for example caused by an insufficient water supply that is detected too late will increase energy costs and, in the worst case, lead to overheating and, thus, to a plant failure.

This can be remedied by measuring the consumption and calculating the heat output of the cooling circuit.



**moneo|RTM: optimisation of the level monitoring in a calibration plant.**

Flow sensors are calibrated in the calibration plant at ifm prover gmbh.

To ensure maximum measuring accuracy, both hot and cold water is sent through the sensors. The measured values are used for calibration.

# ifm system sales – solutions for your installation from a single source



## Competence:

Trust our application know-how. We have been developing automation solutions for our customers for 50 years and know tomorrow's requirements.

## Automation from a single source:

We do not only offer hardware, but also the matching software and IT connection.

## Personal:

You have a permanent contact who supports your project on site.

## Together:

We support your project from advice and quotation to set-up. Even after project completion, we will continue to support you as a reliable partner.

### *ifm system consulting.*

You want to make your application transparent? Fans, pumps, compressors or cooling circuits: Our system consultant helps you to find the ideal solution for monitoring your installation. Our service includes competent advice at your site, a fair offer, personal project assistance and support for set-up. We offer sensors, evaluation systems and software for connection to ERP systems – all from a single source. Together we will make your project successful.

Do not hesitate to contact us:  
[info@ifm.com](mailto:info@ifm.com)

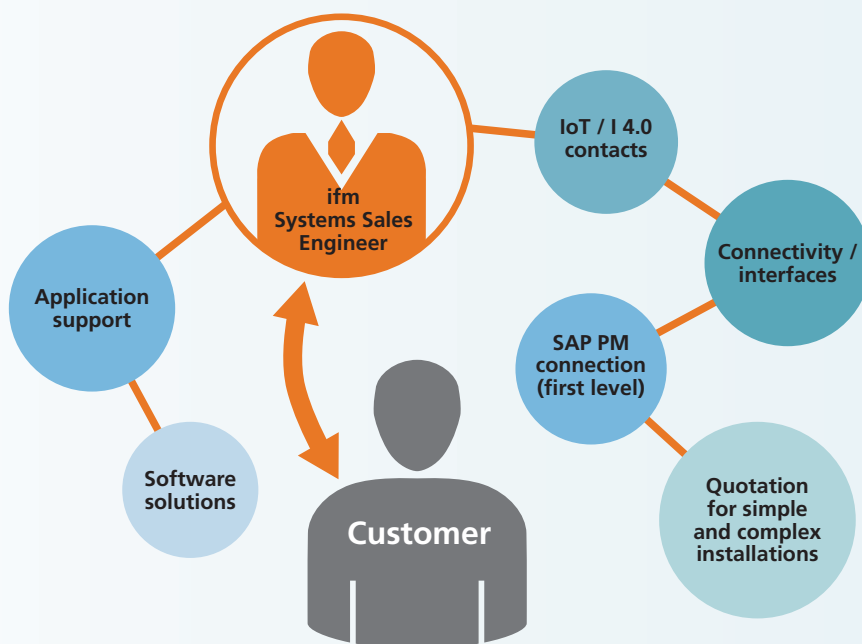

### *ifm system sales network.*

Your personal ifm System Sales Engineer will provide you with the entire ifm know-how to realise and optimise your plant monitoring.





# Reduce costs, prevent downtime, optimise processes – system solutions from ifm.

## Example: fan monitoring

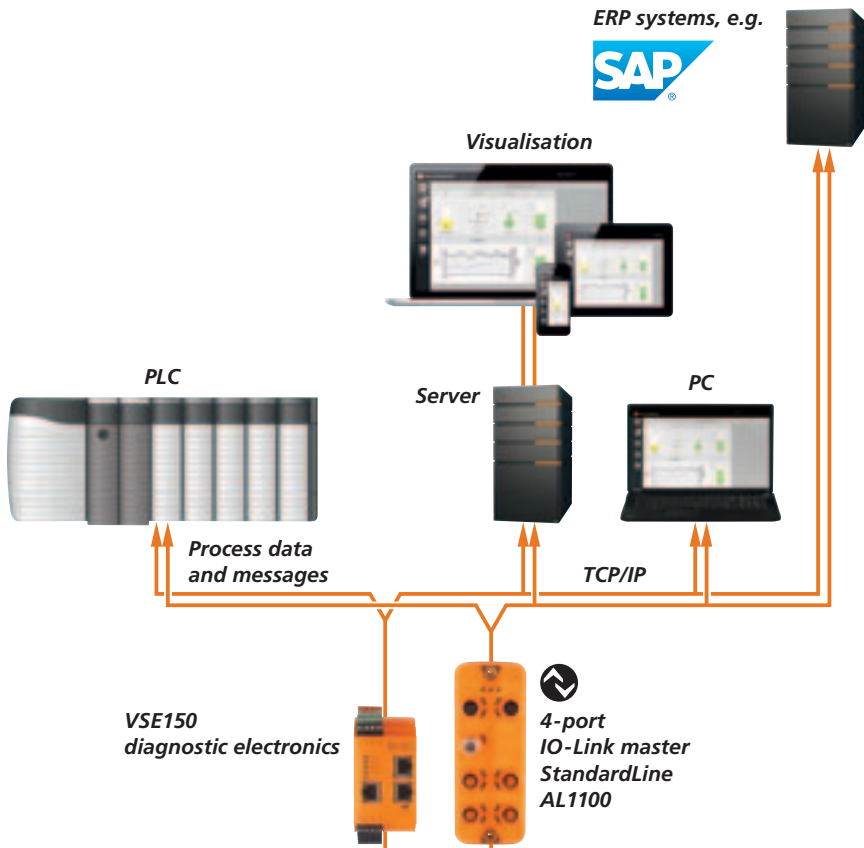

### SMARTOBSERVER

#### LR SMARTOBSERVER

The software visualises, logs and exports process data. Maintenance tasks can be planned by means of alarm and notification functions and worldwide connectivity.

LR SMARTOBSERVER has an integrated database and can be installed as a stand-alone or server application.

#### VSE diagnostic electronics

Records process data from sensors, interprets and prepares it and transmits the results to the PLC, PC or higher-level IT systems.

#### IO-Link master

The module records process data from sensors and transmits it to the PLC, PC or higher-level IT systems. It offers all advantages and possibilities of IO-Link.

**Detection of unbalance on rotor blades**  
With the VSE150 diagnostic electronics and the VSA001 vibration sensor

**Vibration monitoring on bearings**  
With the VSE150 diagnostic electronics and the VSA001 vibration sensor

**Speed monitoring**  
With the VSE150 diagnostic electronics and an inductive sensor

**Filter monitoring**  
With the AL1100 IO-Link master and the PQ3809 pressure sensor

**Vibration monitoring on motors**  
With the VSE150 diagnostic electronics and the VSA001 vibration sensor

**Temperature monitoring on motors**  
With the VSE150 diagnostic electronics and the TS2229 + TP3237 temperature sensors

Contact us: [info@ifm.com](mailto:info@ifm.com)  
Or visit our webshop:  
[ifm.com](http://ifm.com)

# The ifm sales platform



## Overview:

The ifm product range is clearly structured and the individual product platforms ensure quick orientation.

## Selectors:

Choose between the most important technical data and you will get the product selection suitable for your requirements.

## Compare:

You can compare the technical data of up to 3 products. Differences are marked in colour.

## Search and find:

Enter the search term in the full text search and get suggestions for products, topics and product groups.

## Order:

We provide a quick-order and csv import function for the shopping basket on the product pages.



### More clarity

For each product group you can make a first selection via the platforms.

A clear visual language and explanatory texts give you a first impression of the products.



### Compare products with each other

The selectors are the heart of the product search. The displayed selection criteria are adapted to each product range and the technical features of the products. The results can be displayed as tiles or lists.





### **Easy purchasing**

*You are in control of everything in the shopping basket: quantity, modes of shipment and payment. We provide you with everything you can expect from a modern shop.*

*Customers relying on long-standing tried-and-tested articles can quickly order by entering the article number in the shopping basket. This saves time, in particular when a product has to be quickly reordered.*

*Navigation in the menu structure is no longer necessary.*



### **For all types of display**

*Whether PC, laptop, tablet or smartphone – the design of the sales platform adapts to any screen size thus increasing user-friendliness. This also makes it possible to buy products using mobile equipment such as a smartphone.*

**Try us.**  
Click here to directly get to our homepage:  
[ifm.com](http://ifm.com)





## Go ifmonline!

Browse, select, order  
in the ifm webshop

**ifm.com**



**ifm – close to you!**



**Position sensors**



**Sensors for  
motion control**



**Industrial imaging**

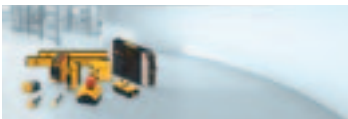

**Safety technology**



**Process sensors**



**Industrial  
communication**



**IO-Link**



**Identification systems**



**Condition monitoring  
systems**



**Systems for  
mobile machines**



**Connection  
technology**



**Software**



**Power supplies**



**Accessories**

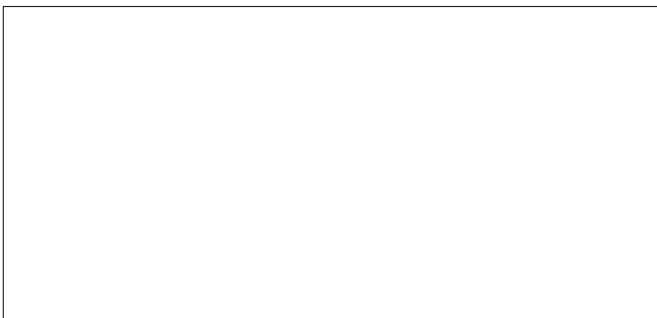

ifm electronic gmbh  
Friedrichstraße 1  
45128 Essen  
Tel. +49 / 201 / 24 22-0  
Fax +49 / 201 / 24 22-1200  
E-mail info@ifm.com

**5 YEARS**  
Warranty  
on ifm products